

# Casement Windows

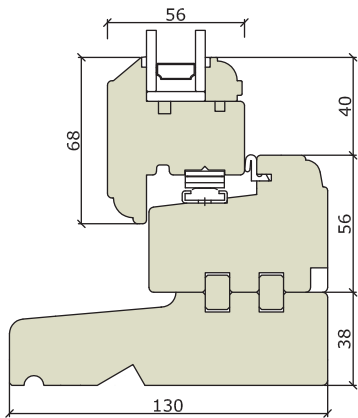

## Casement Lipped - Traditional

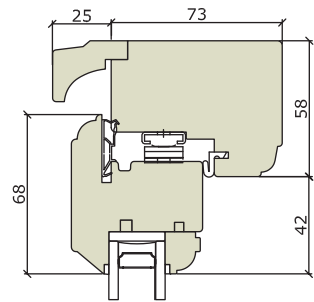
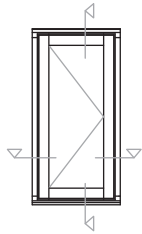

Sub-Cill  
(Various sizes available)

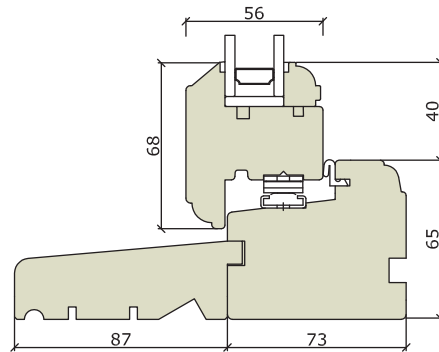

Cill Extension  
(Various sizes available)

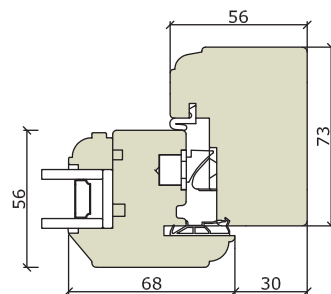
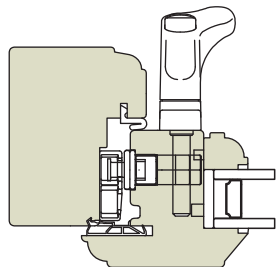

## Casement Lipped - Contemporary

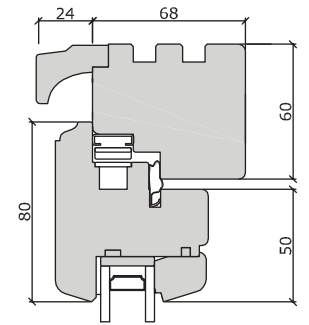
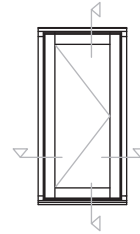

Whilst every care has been taken in producing this document, Bereco Ltd cannot be held responsible for any errors. The profiles within this document are as accurate as possible and were correct at the time of printing and show typical sections for standard glazing. Please note due to our wide range of glazing options, section sizes may alter due to glass specification specified. Please refer to our resource centre for full our full range of sectional details. Due to our continued commitment to product design and development we reserve the right to change the design without prior notice.

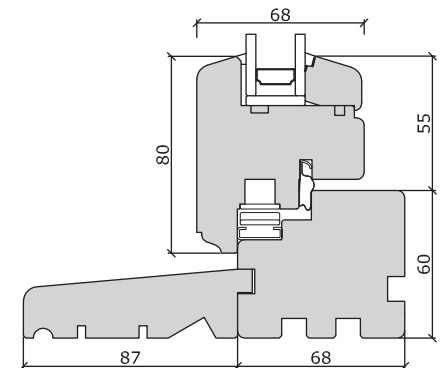

Cill Extension  
(Various sizes available)

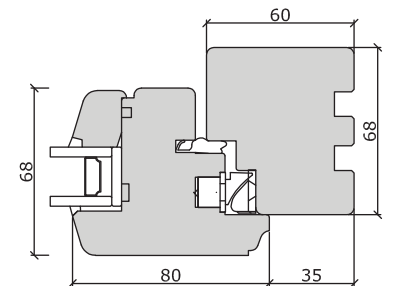
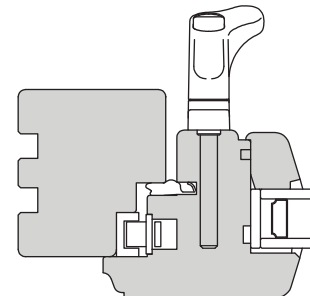

# Casement Windows



## Casement Flush - Traditional

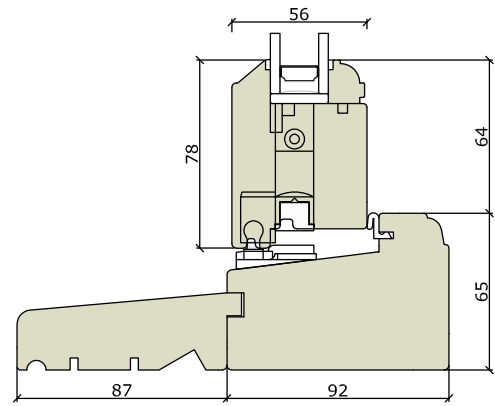
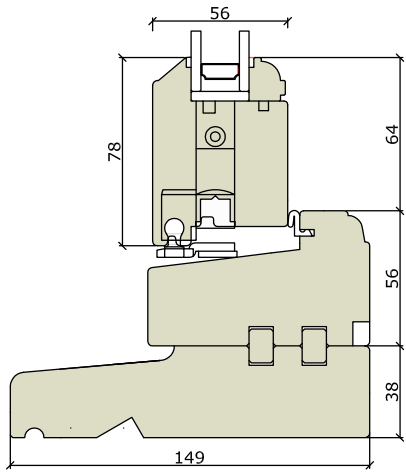
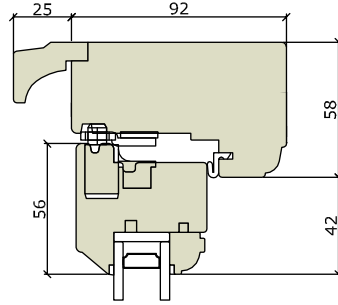
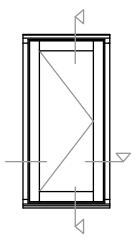

Sub-Cill  
(Various sizes available)

Cill Extension  
(Various sizes available)

## Casement Flush - Heritage

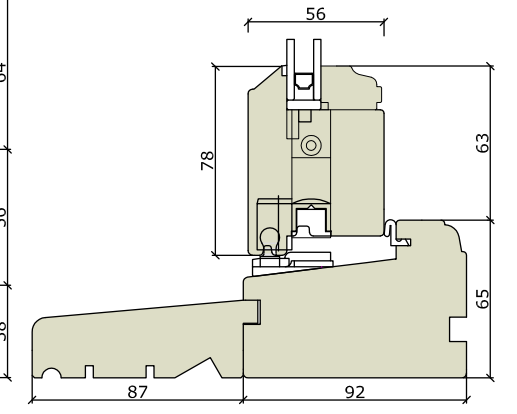
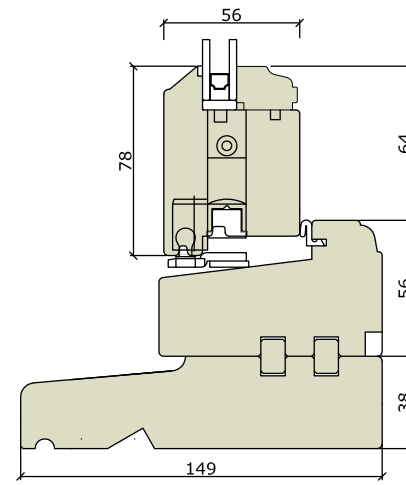
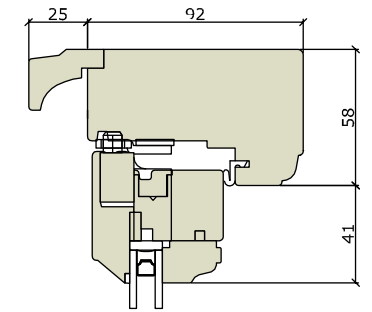
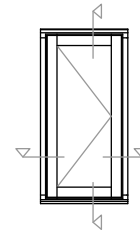

Sub-Cill  
(Various sizes available)

Cill Extension  
(Various sizes available)

