



# CHOOSE YOUR STYLE

The complete guide to styling your  
Bereco timber windows & doors.

 Bereco



Traditional Flush Casement | RAL 7030 Stone Grey | Art Designed By @greenliliart - www.greenlili.com

# SUSTAINABLE. SECURE. FUNCTIONAL. BEAUTIFUL.

New windows and doors are an investment one which will not only look great adding significant kerb appeal but that will add value to your home.

One of the biggest benefits of choosing timber windows and doors is that they can be customised but with so many options to choose from it can be hard to know where to start.

At Bereco we don't impose standards on you; there are no standard sizes, designs or colours because we understand that you and your home are unique.

Our Choose Your Style brochure has been designed to guide you through making these choices and designing the windows that are right for you and your property. Inside you will find details of our window and door styles along with a step by step finishing guide.



## Contents

Our World, Your Home	4
Our Warranties	6
<b>Casement Windows</b>	<b>8</b>
Flush Casement	9
Lipped Casement	10
Casement Details	12
Casement Sections	13
<b>Sliding Sash Windows</b>	<b>14</b>
Sliding Sash Spiral Balance	15
Sliding Sash Cords & Weights	16
Sliding Sash Details	17
Sliding Sash Sections	19
<b>Entrance Doors</b>	<b>20</b>
<b>Creative Doors</b>	<b>22</b>
<b>French Doors</b>	<b>24</b>
Flush French Doors	25
Lipped French Doors	26
Entrance & French Door Sections	27
Entrance & French Door Details	28
Entrance & French Door Ironmongery	30
<b>Your Choice Matters</b>	<b>32</b>
Choose Your Timber	34
Choose Your Glazing	35
Choose Your Mouldings & Bars	36
Choose Your Finish	38
Customise With Glazing & Bars	40
Finishing Touches	42
Our Showroom	43

## TWO DECADES OF EXPERIENCE

Over the last 20 years Bereco have supplied over **250,000** wooden windows and doors to projects of all shapes and sizes across the UK. From Grade II Listed castles, to quaint period cottages and contemporary new builds, we have the experience and products to suit you and your home.

## REDUCING YOUR CARBON FOOTPRINT

300 billion tons of carbon are stored in our forests across the world. When harvested to make wooden windows and doors the wood retains the carbon store making them carbon negative. You can **reduce your carbon footprint** by **160kgs CO2e\*** for every Bereco timber window and door you buy rather than a uPVC window or door.

## HELPING THE WORLDS FORESTS TO GROW

Bereco make a conscious choice to supply our wooden windows and doors made from nothing but **FSC® 100%** or **100% PEFC Certified** timber. This ensures that our products help in the fight against deforestation.

## INVEST IN YOUR HOME

Timber windows have the **lowest lifetime cost** in comparison to uPVC windows, with a life expectancy of around **60 years** compared to just 25-35 years\* from uPVC.

## ENERGY EFFICIENT

Our timber windows and doors are designed with optimum energy efficiency in mind. Timber is an excellent insulator, and we utilise high performance glazing and weather seals to go above and beyond the requirements of the building regulations.

## YOUR HEALTH AND WELLBEING

With exposure to noise over long periods of time being linked to health issues such as heart disease and dementia the noise rating should not be overlooked. Our windows with 24mm double glazing offer a **sound reduction of 33dB** and our specially designed acoustic double glazed units offer sound reduction of up to **42dB**, ideal for properties with traffic noise or that are close to an airport.

# OUR WORLD YOUR HOME



## YOU DON'T HAVE TO COMPROMISE ON STYLE TO BE SECURE

Bereco timber windows and doors are all PAS24:2022 certified and come with **enhanced security features** built in as standard. Home insurance approved **multipoint espagnolette** locking and Neighbourhood Watch approved **ERA Fortress** door cylinders make ours some of the most **secure** wooden windows and doors on the market today.

## BEAUTIFULLY BESPOKE

Bespoke timber windows and doors from Bereco can be tailored to suit the style and design of your home. Choose from our range of mouldings and bar designs, stylish handles and fasteners in a range of 10 colours with factory applied paint or stain finishes including **dual colour finishes** that will transform your home.

## COMPLETE PEACE OF MIND

All Bereco timber windows and doors come with a manufacturer's warranty. We are so confident in the quality of our windows and doors and our factory finishing that we give a warranty on our timber for **30 years** and even offer a **10 year warranty** against defects in manufacturing and factory finishes.

## DON'T JUST TAKE OUR WORD FOR IT

To maintain such high standards of quality we undergo **annual testing** of our windows and doors audited by third party certification body **Bluesky Certification**. Schemes covering our products' **weather performance, security, manufacturing, paint application**, and the material sourcing offer a **level of confidence** in what you are buying that you simply cannot get anywhere else.

## GUARANTEED LEAD TIMES

We **guarantee delivery** of our wooden windows and doors in **6-8 weeks** all year round. Our state of the art production facility is supported by a **dedicated sawmill with timber lamination line** and **glass plant** manufacturing our more common types of sealed units ensuring we are in complete control of the key elements needed to meet the deadlines of our customers.



# Our Warranties

New windows and doors are an investment, one which will not only look great but will add value to your property. We have such confidence in our windows and doors that we offer a manufacturers warranty on our entire product collection.



All warranties must be registered at [berecowarranties.co.uk](http://berecowarranties.co.uk)



Contemporary Entrance Door & Sliding Sash Spiral Balance | RAL 9001 Cream | 16mm Bar



Traditional Sliding Sash Spiral Balance & Flush French Doors | RAL 1013 Oyster White | 25mm Ovolo Bar



Traditional Flush Casement | Farrow & Ball Match Ringwood Ground 208

The confidence to offer our warranties comes from our commitment to certification and testing with third party UKAS accredited Bluesky Certification. They annually audit both our products and our production processes for complete peace of mind that your window and doors will stand the test of time.





# Casement Windows

## Classic & Cosy

Traditional Flush Casement | RAL 9016  
Traffic White | 25mm Ovolo Bar

Our beautifully crafted timber casement windows are available in both flush and lipped (stormproof) designs.

They are internally glazed with **easy clean** friction hinges and **home insurance approved multi-point locking** mechanisms, making them the pinnacle of home security.

Whether renovating a country cottage or modernising a family home, a casement window will enhance its character.



Uw Values from **1.0W/m²K**  
(triple glazing)



Wind Load **2400 Pa**  
Tested to perform against winds of **136mph**



Water Tightness **400 Pa**  
Tested to withstand driving rain at **55mph**

# FLUSH CASEMENT

Traditional | Heritage

## Choose Your Style

### Design

Flying mullion (fire escape)

### Mechanism

Maco Rail espagnolette for enhanced security

### Hinges

Easy clean friction with built in restrictor  
90° Egress (fire escape)  
Hinges to fixed sashes for easy installation

### Accessories

Casement stays  
Auto-latch restrictors

### Bars

**Traditional:** 16mm (lambs tongue)  
25mm, 35mm (ovolo), 48mm (solid)  
**Heritage:** 16mm, 25mm, 35mm (lambs tongue), 48mm (solid)

See pages 36-37 for more info

### Vents

Frame head - 4600 EA

### Cills

Extensions: 25mm, 47mm, 62mm, 75mm, 87mm, 100mm, 114mm, 125mm, 140mm  
Solid sub-cill: 112mm, 134mm, 149mm  
Sub-cill + extension: (25mm - 140mm)

### Glazing



Double



Triple



Acoustic



SlimLine\*



Single\*

\*Only available on Heritage Range

### Uw Range

1.0-1.4 W/m²K



33-42dB

## Bereco Flush Casement Features

- ✓ **Flush Sash**  
An authentic finish is created by the sash sitting completely flush with external frame.
- ✓ **78mm Deep Bottom Rail**  
A deep bottom sash rail ensures a characterful appearance in keeping with classic flush casements.
- ✓ **Slim Sections**  
Designed with 56mm sash sightlines to create an authentic finish and maximise glazing and natural light.
- ✓ **Maco Inline Espagnolette**  
A multi-point espagnolette with adjustable locking cams.
- ✓ **Dummy Sashes**  
A dummy sash to non-opening lights provides symmetry.
- ✓ **Easy Clean Friction Hinge**  
Opening to 60° this modern style hinge allows easy cleaning of the sash from the inside.
- ✓ **Secure Night Vent Position**  
A secure night vent position allows the sash to be locked in a slightly open position allowing ventilation.
- ✓ **179mm Cill**  
An 87mm cill extension as standard provides 179mm from front to back. Includes internal window board groove.
- ✓ **High Quality Handles**  
Traditional handles in a range of timeless finishes. (see page 12)

Image Shows: Traditional Flush Casement | 25mm Ovolo Bar  
Polished Chrome Bulb End Handle + Stay

# LIPPED CASEMENT

Traditional

## Choose Your Style

### Design

Flying mullion (fire escape)

### Mechanism

Maco Rail for enhanced security

### Hinges

Easy clean friction with built in restrictor  
90° Egress (fire escape)  
Hinges to fixed sashes for easy installation

### Accessories

Casement stays  
Auto-latch restrictors

### Bars

16mm (lamb's tongue)  
25mm, 35mm (ovolo)  
48mm (solid)

See pages 36-37 for more info

### Vents

Frame head - 4600 EA

### Cills

Extensions: 25mm, 47mm, 62mm, 75mm,  
87mm, 100mm, 114mm, 125mm, 140mm  
Solid sub-cill: 93mm, 115mm, 130mm  
Sub-cill + Extension: (25mm - 140mm).

### Glazing



Double Triple Acoustic

### Uw Range

1.0 - 1.4 W/m<sup>2</sup>K



## Bereco Traditional Lipped Casement Features

- ✓ **Lipped Sash**  
A modern stormproof finish, the sash lips over the outside edge of the frame.
- ✓ **Slim Sections**  
Designed with 68mm sash sightlines to create an authentic finish and maximise glazing and natural light.
- ✓ **Dummy Sashes**  
A dummy sash to non-opening lights provides symmetry.
- ✓ **Maco Inline Espagnolette**  
A multi-point espagnolette with adjustable locking cams.
- ✓ **Easy Clean Friction Hinge**  
Opening to 60° this modern style hinge allows easy cleaning of the sash from the inside.
- ✓ **Secure Night Vent Position**  
A locking handle with secure night vent position allows the sash to be locked in a slightly open position allowing ventilation.
- ✓ **160mm Cill**  
An 87mm cill extension as standard provides 160mm from front to back. Includes internal window board groove.
- ✓ **High Quality Handles**  
Traditional handles in a range of timeless finishes. (see page 12)

Image Shows: Traditional Lipped Casement | Easy Clean Hinge  
16mm Lamb's Tongue Bar | Antique Black Monkey Tail Handle + Stay.

# LIPPED CASEMENT

Contemporary

## Choose Your Style

### Design

Flying mullion (fire escape)  
Dummy sashes for fixed lights

### Hinges

Easy clean friction with built in restrictor  
90° Egress (fire escape)

### Accessories

Auto-latch restrictor

### Bars

16mm, 25mm, 35mm (pencil round)  
60mm (solid)

See pages 36-37 for more info

### Vents

Frame head - 4600 EA

### Cills

Extensions: 25mm, 47mm, 62mm, 75mm,  
87mm, 100mm, 114mm, 125mm, 140mm

### Glazing



Double Triple Acoustic

### Uw Range

1.0 - 1.4 W/m<sup>2</sup>K



## Bereco Contemporary Lipped Casement Features

- ✓ **Lipped Sash**  
A modern stormproof finish, the sash lips over the outside edge of the frame.
- ✓ **Modern Aesthetic**  
Striking 80mm sash sightlines are perfect for creating a modern aesthetic.
- ✓ **Fixed Lights (Direct Glazed)**  
Fixed lights to non openers as standard with optional dummy sashes to create symmetry.
- ✓ **Siegenia Espagnolette**  
A multi-point espagnolette with adjustable locking cams.
- ✓ **Easy Clean Friction Hinge**  
Opening to 60° this modern hinge allows easy cleaning of the sash from the inside.
- ✓ **155mm Cill**  
An 87mm cill extension as standard provides 155mm from front to back. Includes internal window board groove.
- ✓ **High Quality Handles**  
Connoisseur and bulb end handles in a choice of 10 finishes. (see page 12)

Image Shows: Contemporary Lipped Casement | Easy Clean Hinge  
16mm Pencil Round Bar | Satin Chrome Connoisseur Handle

# Casement Details

## Popular Styles

A selection of popular bar patterns

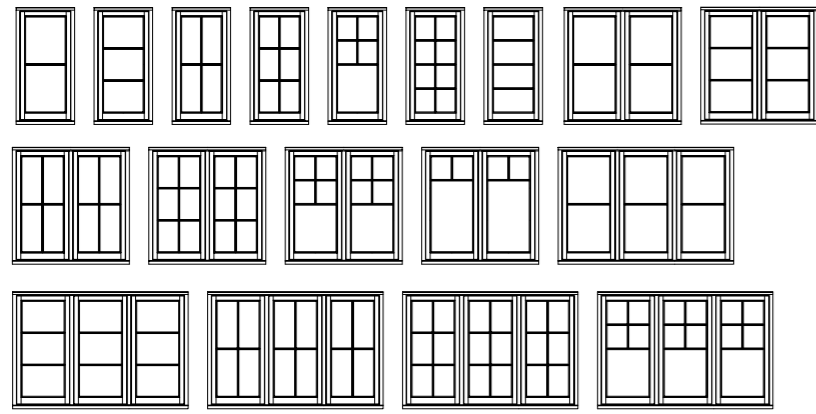

## Bespoke Styles

A selection of popular bespoke styles

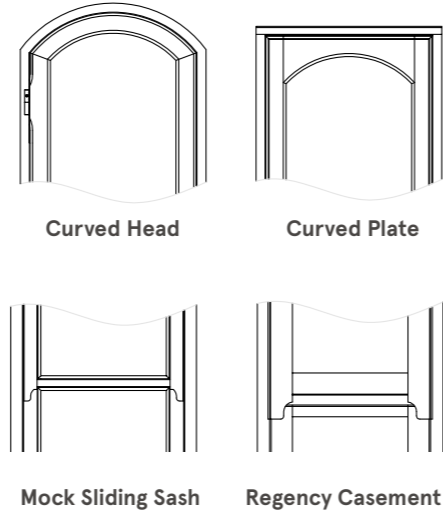

## Casement Handles & Stays

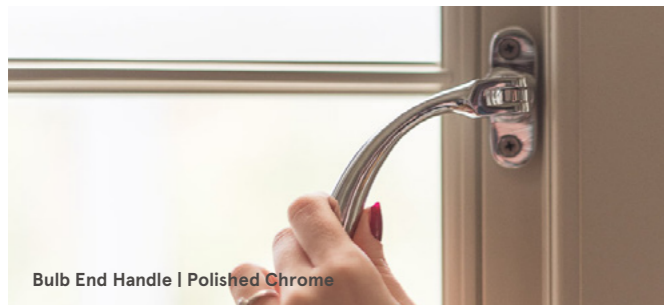

### Bulb End

Contemporary, Traditional & Heritage | Locking, Non-Locking



### Monkey Tail

Traditional & Heritage | Locking, Non-Locking

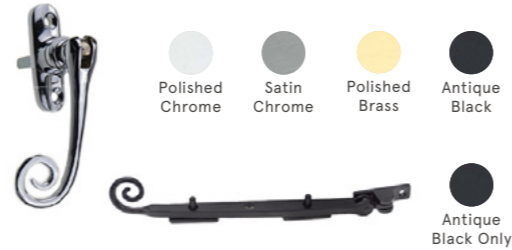

### Connoisseur

Contemporary, Traditional & Heritage | Locking, Non-Locking



### Round Bar

Traditional & Heritage | Locking, Non-Locking



# Casement Sections

## Contemporary Lipped Casement

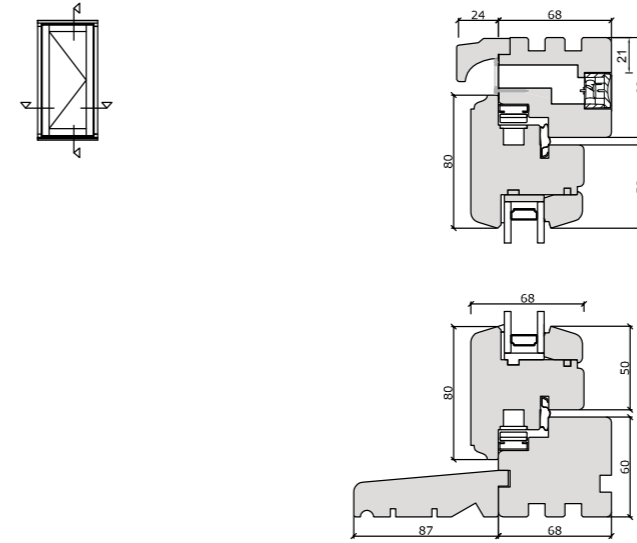

## Traditional Lipped Casement

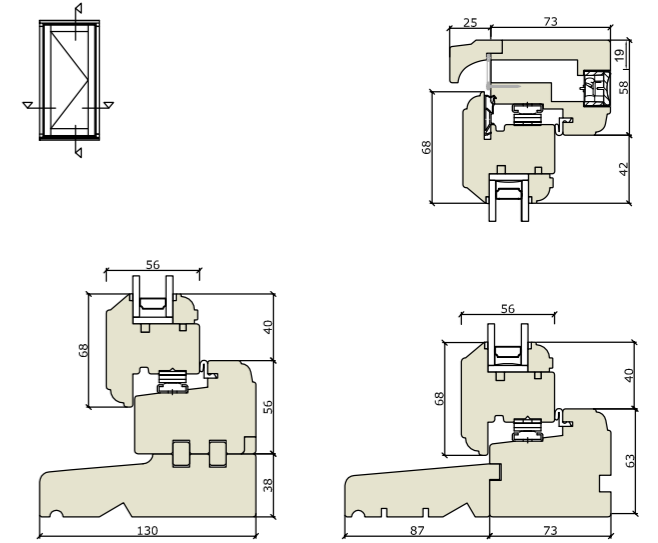

## Traditional Flush Casement

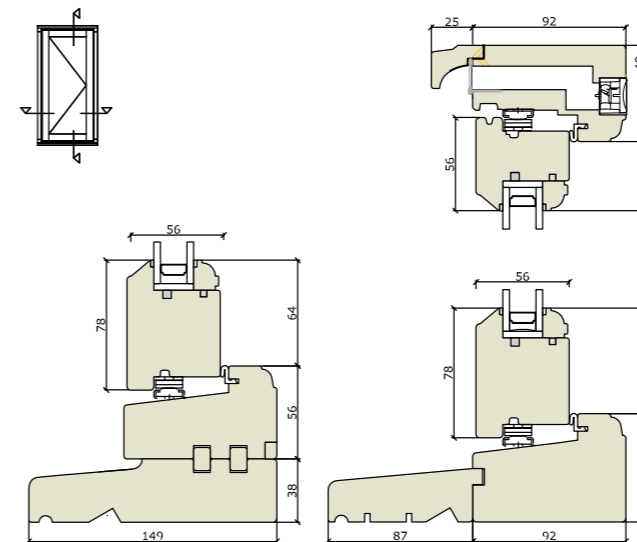

## Heritage Flush Casement

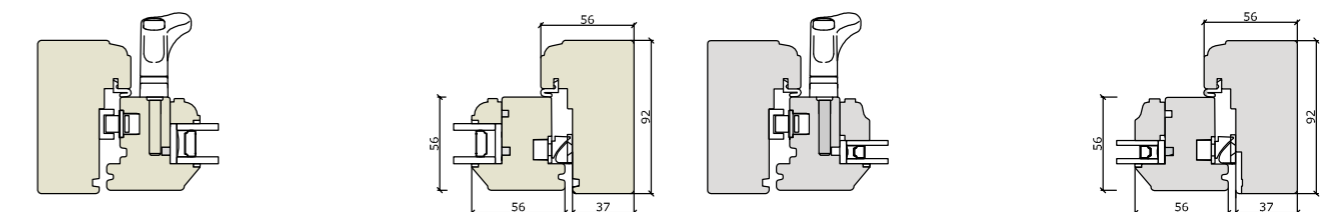
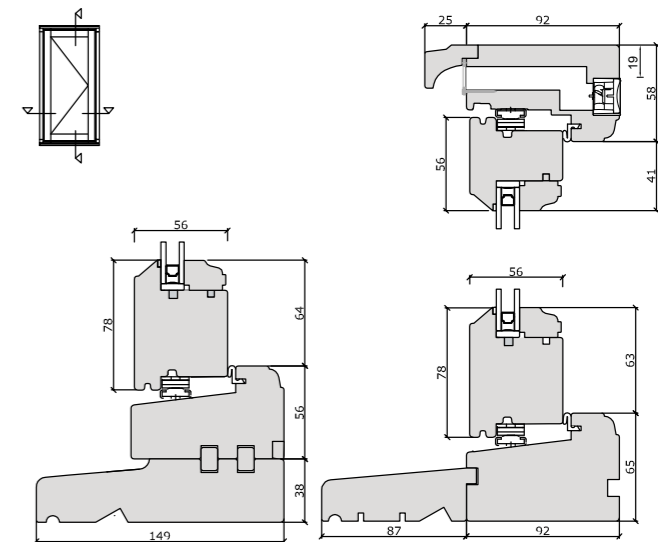



# Sliding Sash Windows

Time Honoured Tradition

Bereco sliding sash windows have been designed to include **traditional features** whilst incorporating modern operation, technology and energy efficiency. Available in either spiral balance or cords and weights with an exclusive collection of **decorative horns** and **elegant sash fittings**.

Whether you are renovating a Victorian townhouse or an Edwardian cottage you will find a sliding sash to suit the unique character of your home.



Uw Values from  
**0.9W/m<sup>2</sup>K**  
(triple glazing)



Wind Load  
**2400 Pa**  
Tested to perform  
against winds of  
**136mph**



Water Tightness  
**400 Pa**  
Tested to  
withstand driving  
rain at **55mph**

# SPIRAL BALANCE

Contemporary | Traditional | Heritage

## Choose Your Style

### Design

Bespoke sash divides  
Both sashes fixed, top/bottom sash fixed  
Increased bottom rail  
Fully concealed spiral balance detail

### Accessories

Ring pulls  
D handles

### Decorative Horns

No horns  
Horns to top & bottom sashes

### Bars

**Contemporary:** 16mm, 25mm, 35mm  
(pencil round), 60mm (solid)  
**Traditional:** 16mm (lamb's tongue),  
25mm, 35mm (ovolo), 48mm (solid)  
**Heritage:** 16mm, 25mm, 35mm (lamb's  
tongue), 48mm (solid)  
See pages 36-37 for more info

### Vents

Concealed frame head - 4600 EA

### Cill

Extensions: 25mm, 47mm, 62mm, 75mm,  
87mm, 100mm, 114mm, 125mm, 140mm

### Glazing



Double



Triple



Acoustic



SlimLine\*



Single\*

\*Only available on Heritage Range

### Uw Range

**0.9 - 1.4 W/m<sup>2</sup>K**



## Bereco Sliding Sash Spiral Balance Features

- ✓ **Opening Sashes**  
Both sashes slide vertically with 50/50 sash divide as standard.
- ✓ **Semi-Concealed Spiral Balances**  
Sensitively designed with semi-concealed spiral balances housed within the frame. Balances available in white, cream, brown and black.
- ✓ **Decorative Horns**  
Decorative horns are included to top sashes as standard. Choose from our range of exclusive sash horn designs. (see page 18)
- ✓ **Flush Cill**  
168mm sole section on Contemporary and Traditional and a 140mm sole section on Heritage Range from front to back. Includes internal window board groove.
- ✓ **Sash Restrictor**  
Ventlock (key locking) sash restrictors are included as standard to all Bereco Contemporary and Traditional sash windows. Push button ventlocks and Angel Ventlocks are also available. Heritage Range includes Heritage sash restrictor.
- ✓ **Sash Fittings**  
Sash fasteners, sash lifts and sash restrictors are included as standard.

Image Shows: Contemporary Sliding Sash Spiral Balance  
Polished Chrome Fitch Fasteners + Hook Lifts

# CORDS & WEIGHTS

Contemporary | Traditional | Heritage

## Choose Your Style

### Design

Bespoke sash divides  
Both sashes fixed, top/bottom sash fixed.  
Increased bottom rail

### Mechanism

Simplex fittings allowing easy cleaning.

### Accessories

Ring pulls  
D handles

### Decorative Horns

No horns  
Horns to top & bottom sash

### Bars

**Contemporary:** 16mm, 25mm, 35mm (Pencil Round), 60mm (Solid)  
**Traditional:** 16mm (Lamb's Tongue), 25mm, 35mm (Ovolo), 48mm (Solid)  
**Heritage:** 16mm, 25mm, 35mm (Lamb's Tongue), 48mm (Solid)  
See pages 36-37 for more info

### Vents

Concealed frame head - 4600 EA

### Cills

Extensions: 25mm, 47mm, 62mm, 75mm, 87mm, 100mm, 114mm, 125mm, 140mm

### Glazing



Double Triple Acoustic



SlimLine\* Single\*

\*Only available on Heritage Range

### Uw Range

0.9 – 1.4 W/m<sup>2</sup>K



## Bereco Sliding Sash Features

- Opening Sashes**  
Both sashes slide vertically with 50/50 sash divide as standard.
- Traditional Pulley & Weights**  
An authentic pulley and weights system featuring round end pulley wheels and cotton sash cords allowing window heights of up to 3m.
- Decorative Horns**  
Decorative horns are included to top sashes as standard. Choose from our range of exclusive sash horn designs. (see page 18)
- Flush Cill**  
168mm sole section on Contemporary and Traditional and a 140mm sole section on Heritage Range from front to back. Includes internal window board groove.
- Sash Restrictor**  
A sash restrictor as standard provides child safety. Choose from Ventlock (key locking) or Angel Ventlock (push button). Heritage Range includes Heritage Sash Restrictor.
- Sash Fittings**  
Sash fasteners, sash lifts and sash restrictors are included as standard.

Image Shows: Traditional Sliding Sash Cords & Weights | 25mm Ovolo Bar Polished Chrome Fitch Fasteners & Hook Lifts

# Sliding Sash Details

## Popular Styles

A selection of popular bar patterns

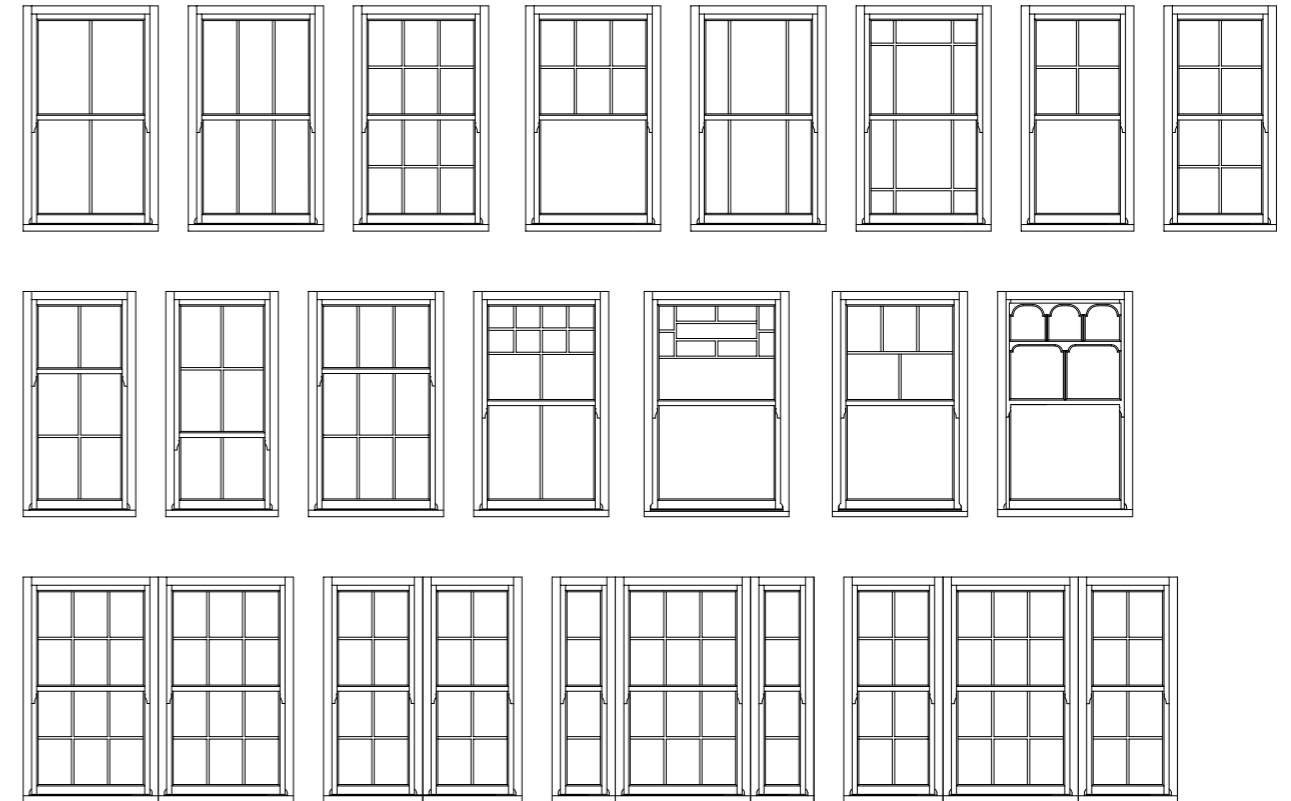

## Fasteners & Accessories

### Sash Fasteners

Contemporary, Traditional & Heritage | Locking, Non-Locking

FITCH FASTENER



BRIGHTON FASTENER



### Sash Lifts

Contemporary, Traditional & Heritage

HOOK LIFT



D HANDLE



RING PULL



### Sash Restrictor

Contemporary & Traditional Only

VENTLOCK

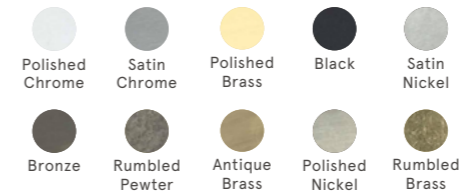

ANGEL VENTLOCK

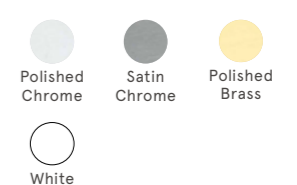

# Sliding Sash Details

Bereco have over a decades experience in supplying timber sash windows for properties governed by the requirements of conservation. We offer traditional curves and arches on our frames, our glazing and our glazing bars and offer a choice of 7 sash horn designs that provide a perfect match to the existing design of any building.

## Horn Collection

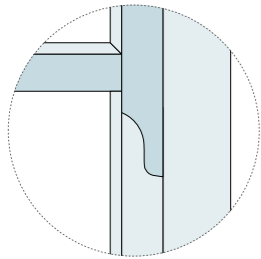

**Classic**  
\*Standard Contemporary

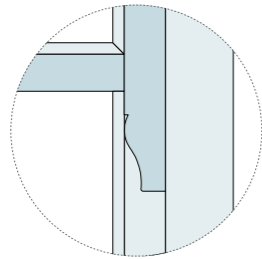

**Belsay**  
\*Standard Traditional & Heritage

## Exclusive Horn Collection

Available on Traditional & Heritage Range

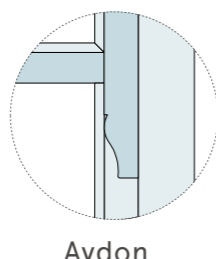

**Aydon**

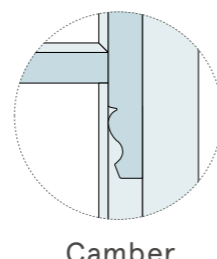

**Camber**

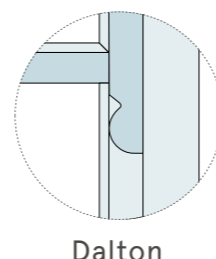

**Dalton**

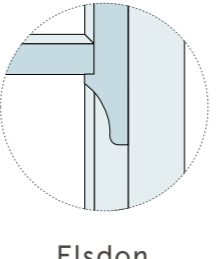

**Elsdon**

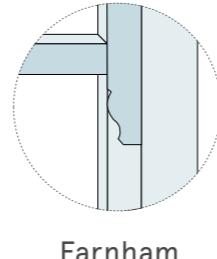

**Farnham**

## Bespoke Styles



### Feature Fanlight

Whether arched head or square, fanlights provide a feature and are ideal for large openings. Georgian bars have been designed to line through with the sash window below.



### Curved On Plan

With Bereco curved on plan sash windows the window frame including head and sole; the opening sashes and the glass are all curved.



### Head Facing Curved

Suitable for reveal situations, allowing a square head window to sit behind a curved outer skin. The sash mirrors the outer curve in order to appear as a curved head externally.



### Curved Head

Curved head windows give a touch of elegance to a property. Our sliding sash windows can be arched to suit the radius of the opening.

# Sliding Sash Sections

## Contemporary Sliding Sash

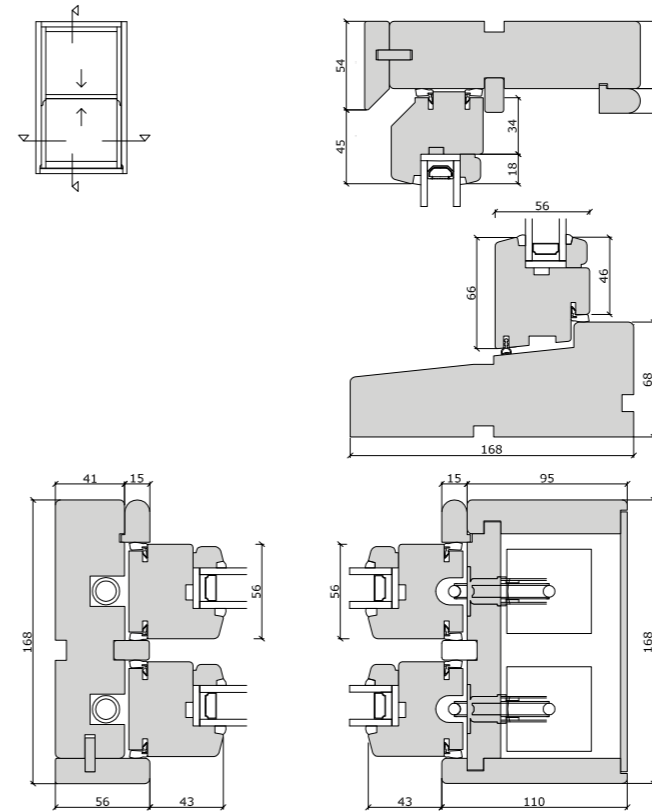

## Traditional Sliding Sash

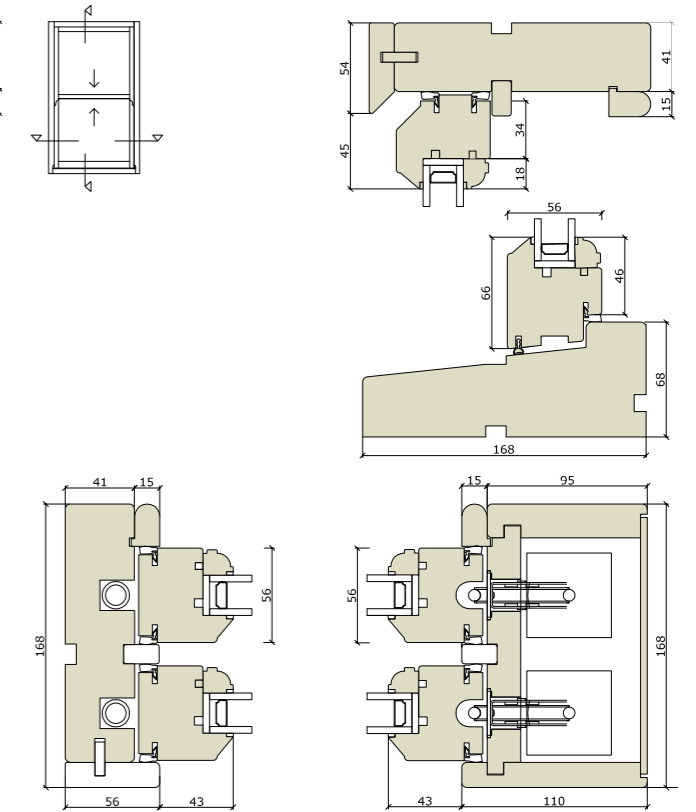

## Acoustic Sliding Sash

Contemporary / Traditional Only

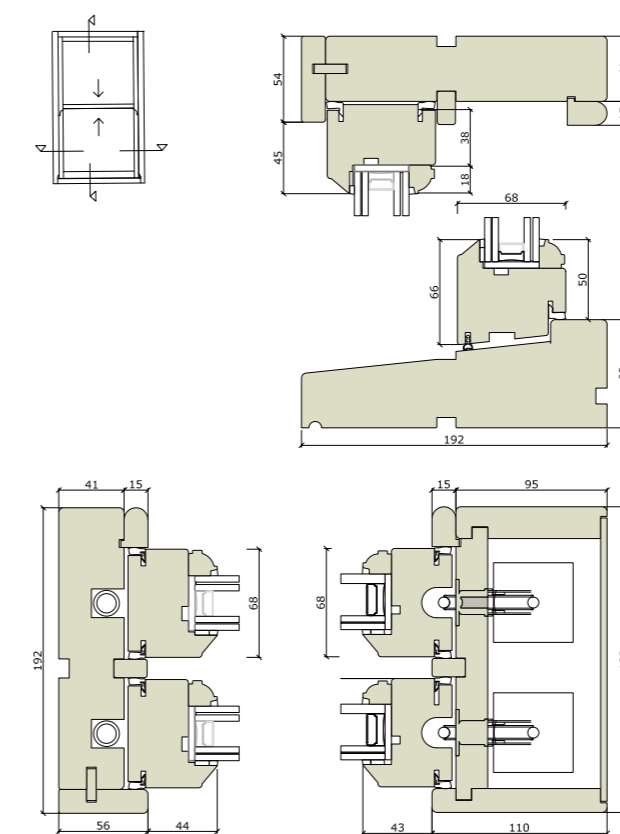

## Heritage Sliding Sash

SlimLine Glazing (Single Glazing Available On Request)

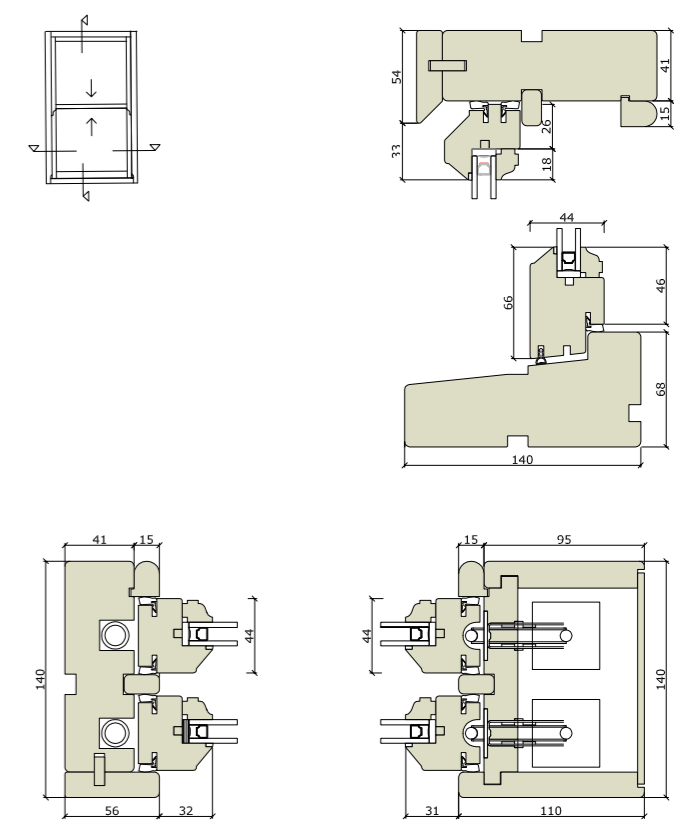

Whether you are looking for a grand entrance door to your Georgian townhouse or a rustic entrance to your country cottage, with custom-made designs you can create an aesthetic which is perfectly tailored to you and your home.



# Entrance Doors

Create Kerb Appeal

Traditional Flush French Door Farrow & Ball  
Colour Match No.15 Bone | 16mm Bar

Design a unique statement entrance with a completely bespoke entrance door from Bereco supplied pre-hung ready for installation.

At the forefront of home security and the epitome of style, all Bereco doors include **multi-point espagnolette locking** and feature an **ERA Fortress 3 Star Neighbourhood Watch approved cylinder** for complete peace of mind. With a door leaf thicknesses (68mm) nearly an inch deeper than standard products available on the market, the reassuring **solid quality feel** is unparalleled.

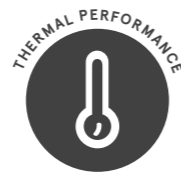

Ud Values from **1.0W/m<sup>2</sup>K**  
(triple glazing)



Wind Load **800 Pa**  
Tested to perform against winds of **78mph**



Water Tightness **600 Pa**  
Tested to withstand driving rain at **68mph**

# CLASSIC ENTRANCE DOORS

Contemporary | Traditional

## Choose Your Style

### Design

Bespoke designs  
Choice of 2 panel designs (See page 28)  
Double door  
Inward or outward opening

### Mechanism

3 point key operated espagnolette

### Hinges

SFS - Just 3D  
4th hinge for doors over 2200mm (h)

### Accessories

Thumb-turn cylinder  
Keyed alike  
A range of accessories in matching finishes

### Bars

**Contemporary:** 16mm, 25mm, 35mm (pencil round), 60mm (solid)  
**Traditional:** 16mm (lamb's tongue), 25mm, 35mm (ovolo), 48mm (solid)  
See pages 36-37 for more info

### Threshold

Stormguard aluminium (mobility)  
Matt aluminium/matt gold  
Threshold + extension: 25mm, 47mm, 62mm, 75mm, 87mm, 100mm, 114mm, 125mm, 140mm

### Glazing



Double Triple Acoustic

### Ud Range

**1.0 - 1.4 W/m<sup>2</sup>K**



## Bereco Classic Entrance Door Features

- ✓ **Flush Design**  
The door leaf sits flush with the frame externally to create a seamless finish.
- ✓ **Multi-Point Espagnolette**  
3 point handle operated espagnolette: To lock the door the handle is lifted which engages the espagnolette hooks with the keepers. The cylinder is then locked with a key which engages the third locking point.
- ✓ **Robust Hinges**  
Fully adjustable hinges SFS - Just 3D (stainless steel).
- ✓ **Security**  
ERA Fortress 3 Star Sold Secure Diamond rated cylinder.
- ✓ **Threshold**  
Stormguard aluminium + 140mm hardwood threshold.
- ✓ **Quality Handles**  
Choose from a selection of Euro lever handles styles in up to 10 finishes.
- ✓ **Combining Colour**  
Choose from single colour, dual colour or different colours for the door frame and door leaf.

Image Shows: Entrance Door: H4 With Cylinder Pull  
Polished Chrome Victorian Letterplate + Ring Knocker



# Creative Entrance Doors

## Sleek & Ultra Modern

Bereco's collection of Creative Entrance Doors are **minimalist** in design and feature sharp lines and flush panels that provide an **ultra modern**, industrial feel.

**Thermally insulated panels** with fibreglass reinforcements and aluminium stabilisation layers ensure the highest levels of home security and thermal performance.

To complement these contemporary doors why not team them with our selection of Italian designer door furniture.



Ud Values from  
**0.99W/m²K**



Wind Load  
**800 Pa**  
Tested to perform  
against winds of  
**78mph**



Water Tightness  
**600 Pa**  
Tested to  
withstand driving  
rain at **68mph**

# CREATIVE ENTRANCE DOORS

Contemporary

## Choose Your Style

### Design

Choose from 10 door styles (see page 28)

Double door

Inward or outward opening

### Mechanism

3 point handle operated

3 point handle + key operated

### Hinges

SFS - Just 3D

4th hinge for doors over 2200mm (h)

### Accessories

Thumb-turn cylinder

Keyed alike

A range of accessories in matching finishes

### Bars

Contemporary - 16mm, 25mm, 35mm  
(pencil round), 60mm (solid)

See pages 36-37 for more info

### Threshold

Stormguard aluminium (mobility)

Matt aluminium/matt gold

Threshold + extension: 25mm,  
47mm, 62mm, 75mm, 87mm, 100mm,  
114mm, 125mm, 140mm

### Glazing



Double



Triple



Acoustic

### Ud Range

**0.99 W/m²K**



## Bereco Creative Entrance Door Features

- ✓ **Flush Design**  
The door leaf sits flush with the frame to create a seamless finish.
- ✓ **Smartline Groove**  
Designs are achieved with a flush insulated panel utilising smartline grooves in a variety of designs.
- ✓ **Multi-Point Espagnolette**  
3 point key operated espagnolette where the latch is operated with the key. To fully lock the door the key is turned to engage the three locking points.
- ✓ **Robust Hinges**  
Fully adjustable hinges SFS - Just 3D (stainless steel).
- ✓ **Security**  
ERA Fortress 3 Star Sold Secure Diamond rated cylinder.
- ✓ **Threshold**  
Stormguard aluminium + 140mm hardwood threshold.
- ✓ **Quality Handles & Accessories**  
Choose from a selection of cylinder covers and combine with matching pull handles. (See pages 30-31)
- ✓ **Combining Colour**  
Choose from single colour, dual colour or different colours for the door frame and door leaf.

Image Shows: Creative Door: C6 | Satin Stainless Round Rose Escutcheon + Pull Handle



# French Doors

Elegant Design, Ultimate Performance

Our beautiful collection of French doors are perfect for **opening up your living space** and providing a connection between indoor and outdoor space.

Available in both flush and lipped designs to perfectly complement your window choice, Bereco French doors can be supplied in **single or double leaf configurations** with a variety of sidelights and fanlights.

Customise with panels and bars and a range of distinct ironmongery to achieve your desired home style.

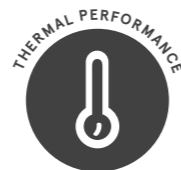

Ud Values from **1.0W/m<sup>2</sup>K** (triple glazing)



Wind Load **800 Pa**  
Tested to perform against winds of **78mph**



Water Tightness **600 Pa**  
Tested to withstand driving rain at **68mph**

# FLUSH FRENCH DOORS

Contemporary | Traditional | Heritage

## Choose Your Style

### Design

Bespoke designs  
Choice of 2 panel designs (See page 28)  
Inward or outward opening

### Mechanism

Double handle operated with handles to both lead and slave leaves.

### Hinges

SFS - Just 3D  
4th hinge for doors over 2200mm (h)

### Accessories

Thumb-turn cylinder  
Keyed alike

### Bars

**Contemporary:** 16mm, 25mm, 35mm (pencil round), 60mm (solid)  
**Traditional:** 16mm (lamb's tongue), 25mm, 35mm (ovolo), 48mm (solid)  
**Heritage:** 16mm, 25mm, 35mm (lamb's tongue), 48mm (solid)

See pages 36-37 for more info

### Vents

Frame head - 4600 EA

### Threshold

Stormguard aluminium (mobility)

Threshold + extension: 25mm, 47mm, 62mm, 75mm, 87mm, 100mm, 114mm, 125mm, 140mm

### Glazing



Double



Triple



Acoustic



SlimLine\*



Single\*

\*Only available on Heritage Range

### Ud Range

1.0 - 1.4 W/m<sup>2</sup>K



## Bereco Flush French Door Features

- ✓ **Flush Design**  
The door leaf sits flush with the frame externally to create a seamless finish.
- ✓ **Multi-Point Espagnolette**  
3 point handle operated espagnolette with handle to lead leaf as standard. To lock the door the handle is lifted which engages the espagnolette hooks with the keepers. The cylinder is then locked with a key which engages the third locking point.
- ✓ **Robust Hinges**  
Fully adjustable hinges SFS - Just 3D (stainless steel).
- ✓ **Security**  
ERA Fortress 3 Star Sold Secure Diamond rated cylinder.
- ✓ **Threshold**  
Stormguard aluminium + 140mm hardwood threshold.
- ✓ **Quality Handles**  
Choose from a selection of Euro lever handles styles in up to 10 finishes.
- ✓ **Combining Colour**  
Choose from single colour, dual colour or different colours for the door frame and door leaf.

Image Shows: Contemporary Flush French Doors | Double Handle | Contemporary Raised Panel | 16mm Pencil Round Bars Polished Chrome Balmoral Handles | Walnut Threshold

# LIPPED FRENCH DOORS

Contemporary | Traditional

## Choose Your Style

### Design

Bespoke designs  
Choice of 2 panel designs (See page 28)  
Inward or outward opening

### Mechanism

Double handle operated with handles to both lead and slave leaves.

### Hinges

4th hinge for doors over 2200mm (h)

### Accessories

Thumb-turn cylinder  
Keyed alike

### Bars

**Contemporary:** 16mm, 25mm, 35mm (pencil round), 60mm (solid)  
**Traditional:** 16mm (lamb's tongue), 25mm, 35mm (ovolo), 48mm (solid)  
See pages 36-37 for more info

### Vents

Frame head - 4600 EA

### Threshold

Stormguard aluminium (mobility)

Threshold + extension: 25mm, 47mm, 62mm, 75mm, 87mm, 100mm, 114mm, 125mm, 140mm

### Glazing



Double Triple Acoustic

### Ud Range

1.0 – 1.4 W/m<sup>2</sup>K



## Bereco Lipped French Door Features

- ✓ **Lipped Design**  
A modern stormproof design where the door leaf lips over the outside edge of the frame.
- ✓ **Multi-Point Espagnolette**  
3 point handle operated espagnolette with handle to lead leaf as standard. To lock the door the handle is lifted which engages the espagnolette hooks with the keepers. The cylinder is then locked with a key which engages the third locking point.
- ✓ **Robust Hinges**  
Fully adjustable hinges SFS - Easy 3D (white, brown, silver).
- ✓ **Security**  
ERA Fortress 3 Star Sold Secure Diamond rated cylinder.
- ✓ **Threshold**  
Stormguard aluminium + 140mm hardwood threshold.
- ✓ **Quality Handles**  
Choose from a selection of Euro lever handles styles in up to 10 finishes.
- ✓ **Combining Colour**  
Choose from single colour, dual colour or different colours for the door frame and door leaf.

Image Shows: Traditional Lipped French Doors | Single Handle  
16mm Lambs Tongue Bar | Polished Chrome Balmoral Handle.

# Entrance & French Door Sections

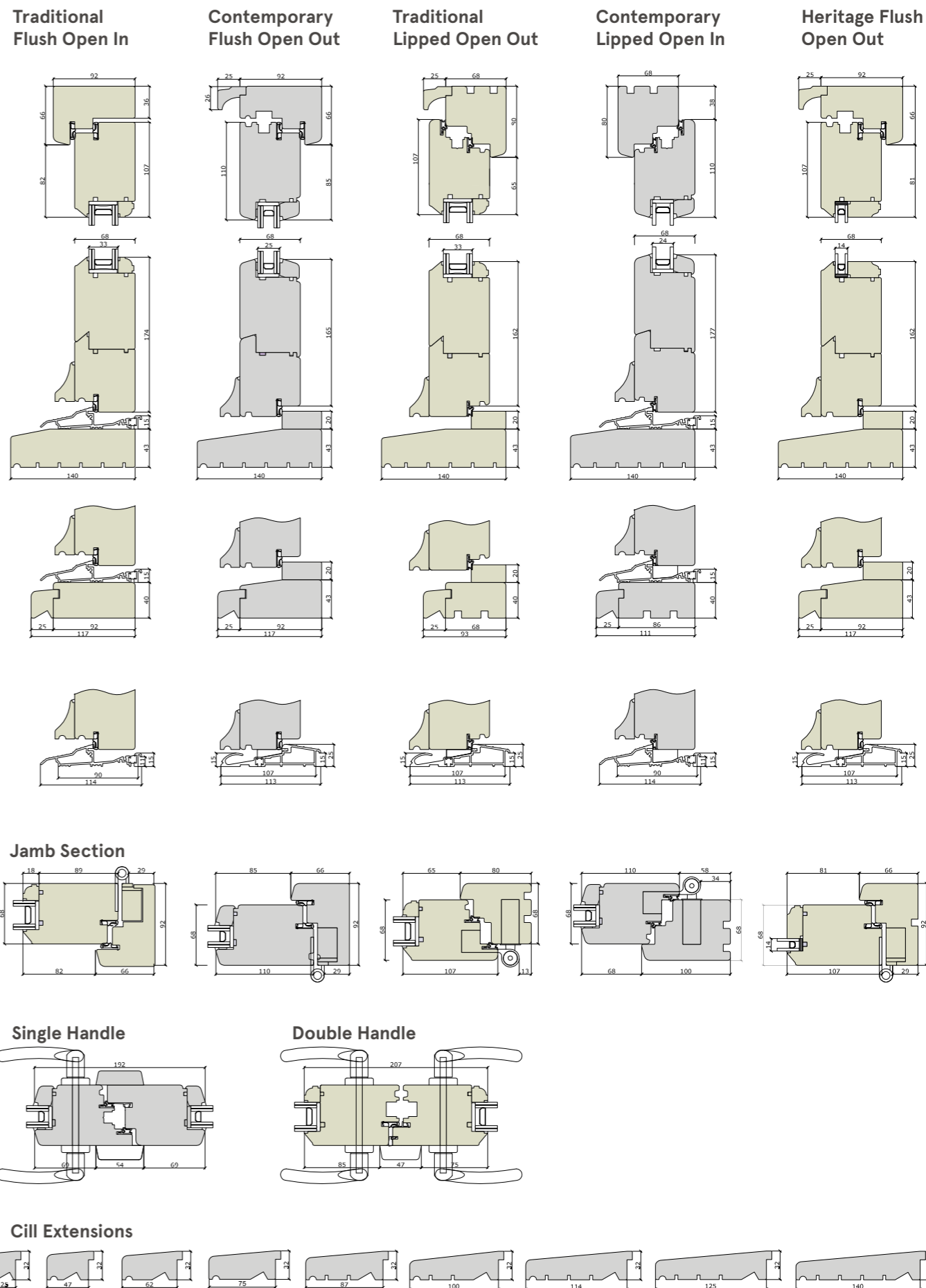

# Entrance Door Details

## Popular Styles

### Classic Doors

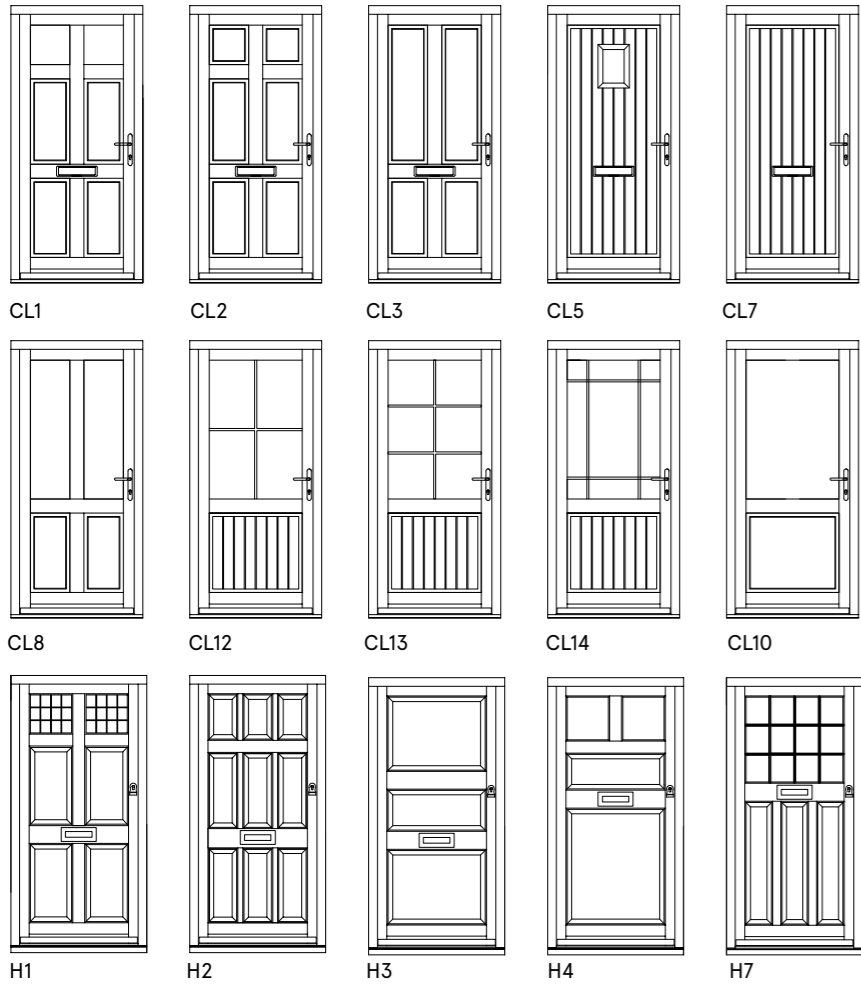

### Creative Doors

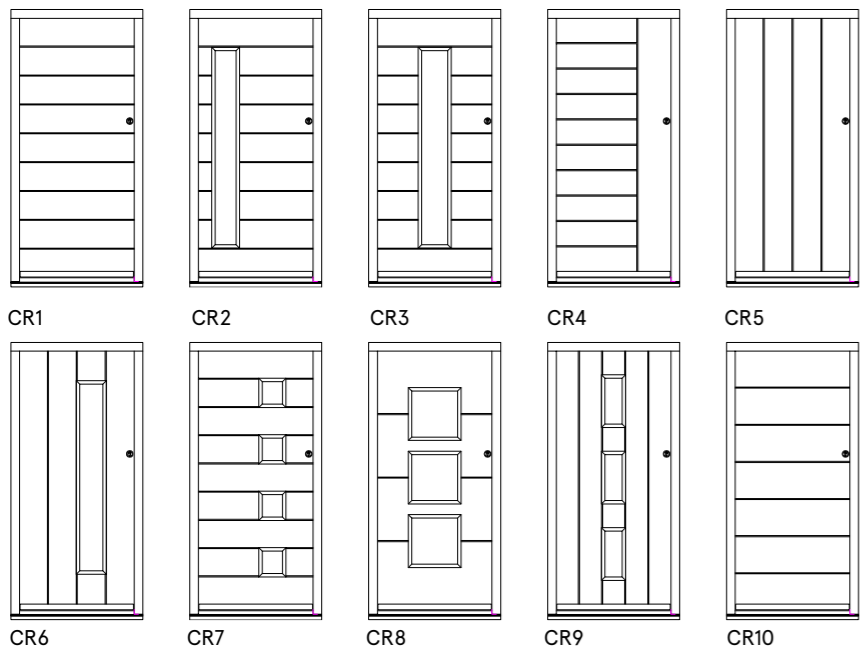

# French Door Details

## Popular Styles



## Entrance & French Door Panels

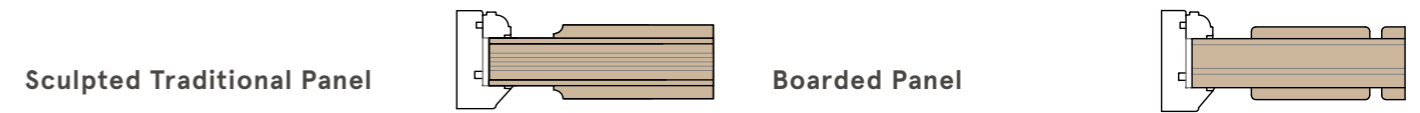

# Entrance & French Door Ironmongery

## Handle Operated

Entrance Door | Creative Door | French Door



Balmoral Handle

**BALMORAL / BALMORAL SWAN**

Polished Chrome | Satin Chrome | Brass Plated | Black | White

**CAIRNGORM**

Antique Black

**BARRINGTON**

Polished Chrome | Satin Chrome | Polished Brass | Black | Satin Nickel

Bronze | Rumbled Pewter | Antique Brass | Polished Nickel | Rumbled Brass

## Key Operated

Entrance Door | Creative Door



Cylinder Pull

**CYLINDER PULL**

Polished Chrome | Satin Chrome | Polished Brass | Black | Satin Nickel

Bronze | Rumbled Pewter | Antique Brass | Polished Nickel | Rumbled Brass

**ROUND ROSE ESCUTCHEON**

Polished Chrome | Satin Chrome | Duo / Polished Satin | Stainless Steel

**BACK TO BACK PULL HANDLE**

Stainless Steel

## Handle & Key Operated

Creative Door Only

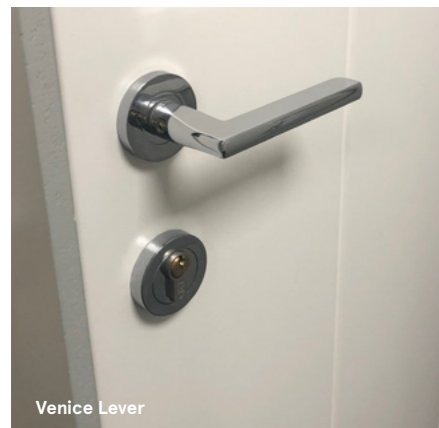

Venice Lever

**AMALFI LEVER**

Polished Chrome | Satin Chrome | Duo / Polished Satin | Stainless Steel

**BAGGS LEVER**

Duo / Polished Satin

**DUNE LEVER**

Polished Chrome | Satin Chrome | Duo / Polished Satin | Stainless Steel

**VENICE LEVER**

Polished Chrome | Satin Chrome | Duo / Polished Satin

## Door Accessories

### Door Knockers

**VICTORIAN URN**

Polished Chrome | Satin Chrome | Polished Brass | Black | Satin Nickel

Bronze | Rumbled Pewter | Antique Brass | Polished Nickel | Rumbled Brass

**DOCTORS KNOCKER**

Polished Chrome | Satin Chrome | Polished Brass | Black | Satin Nickel

Bronze | Rumbled Pewter | Antique Brass | Polished Nickel | Rumbled Brass

**RING KNOCKER**

Polished Chrome | Satin Chrome | Polished Brass | Black | Satin Nickel

Bronze | Rumbled Pewter | Antique Brass | Polished Nickel | Rumbled Brass

### Door Knobs

**LARGE CENTRE DOOR KNOB (86mm)**

Polished Chrome | Satin Chrome | Polished Brass | Black | Satin Nickel

Bronze | Rumbled Pewter | Antique Brass | Polished Nickel | Rumbled Brass

**OCTAGONAL DOOR KNOB**

Polished Chrome | Satin Chrome | Polished Brass

### Letter Plates

**DRAUGHT DODGER LETTER PLATE**

Polished Chrome | Satin Chrome | Brass Plated | Black | White

**VICTORIAN LETTER PLATE**

Polished Chrome | Satin Chrome | Polished Brass



Contemporary Entrance Door | 16mm Bar

**LOCKED MEANS LOCKED.**

Tested to the highest standards and offering the ultimate defence against snapping, picking, bumping and drilling, the ERA Fortress is the only 3" euro cylinder recommended by the Neighbourhood Watch.

**NEIGHBOURHOOD WATCH**

ERA  
FORTRESS  
3" EURO CYLINDER

31



**YOUR CHOICE MATTERS..**



We use only Sustainably Sourced Engineered Defect-Free Timber

## Choose Your Timber

We are passionate about timber and only the finest quality, sustainably sourced wood is used in the production of our windows and doors. Wood, not only has a natural beauty but is a natural insulator ensuring that your home is kept snug and warm.

All our timber windows and doors are manufactured using engineered, defect-free timber which not only ensures quality of finish but increases durability and stability.

This engineered timber is known to be 60% stronger than its solid timber counterparts, resulting in a low maintenance window with an impressive 60 year lifespan.



### Redwood - Scandinavian Pine

A popular choice, redwood features a smooth surface, and achieves excellent durability. Perfect for painted finishes.

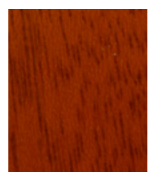

### Hardwood - Dark Red Meranti

Our hardwood comes with full chain of custody. It features a pitted effect surface and a natural red hue to the timber. Perfect for stain finishes.

## Choose Your Glazing

The specification of glass can have a dramatic effect on the performance of windows and doors, home comfort and heating costs. Our windows and doors incorporate double glazed units utilising a Softcoat Low-E coating as standard which provides excellent u values.



### 24MM DOUBLE GLAZING

Contemporary | Traditional

Argon filled as standard offering a centre pane Ug value as low as 1.0 W/m<sup>2</sup>K and overall Uw values of 1.2 W/m<sup>2</sup>K



### 35MM TRIPLE GLAZING

Contemporary | Traditional

Argon filled as standard, with Krypton filled units available offering centre pane Ug values as low as 0.5 W/m<sup>2</sup>K and overall Uw values of 0.8 W/m<sup>2</sup>K (Krypton).

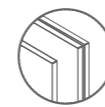

### 24MM & 35MM ACOUSTIC DOUBLE GLAZING

Contemporary | Traditional

Reduce noise levels in the home without compromising on style. 24mm acoustic glazing with overall window ratings up to 38dB and 35mm up to 42dB.

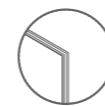

### 16MM SLIMLINE DOUBLE GLAZING

Heritage

This unrivalled krypton filled glazing unit mimics the appearance of single glazing whilst offering improved thermal performance with 8mm warm edge spacers as standard, a centre pane Ug values of 1.2 W/m<sup>2</sup>K, and an overall Uw value of 1.3 W/m<sup>2</sup>K.

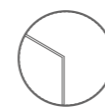

### 4MM SINGLE GLAZING

Heritage

We offer 4mm single glazed units, perfect for homes under strict conservation requirements.

### DIAMANT GLASS

Extra clear Diamant glass with low solar gain is available on request.

### SPACER BARS

Spacer bars can be seen around the perimeter of the glazing. Choose from a wide range of colour options. Warm edge spacers available in white, black, brown and grey can reduce ug values to as low as 1.0 W/m<sup>2</sup>K which will significantly reduce home heating costs.



Traditional Lipped Casement | RAL 9016 Traffic White  
6mm Lead Antique Black

# Choose Your Mouldings & Bars



## Contemporary

Our Contemporary Range features simple lines and shapes including internal pencil round mouldings.

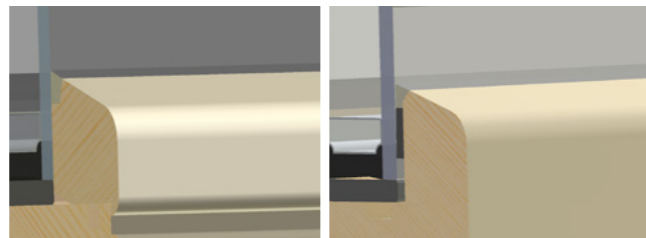

Contemporary Internal

Contemporary External

## Pencil Round Bars

16mm, 25mm, 35mm  
60mm (Solid)

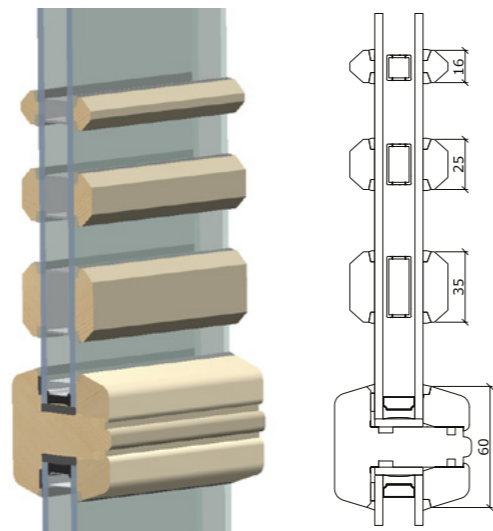

## Traditional

Our Traditional Range features internal ovolo beading and external putty line sash mouldings to enhance the character of your home.

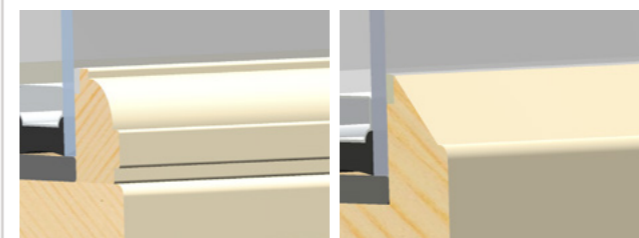

Traditional Internal

Traditional & Heritage External

## Ovolo Bars

16mm (Lambs Tongue),  
25mm, 35mm (Ovolo) | 48mm (Solid)

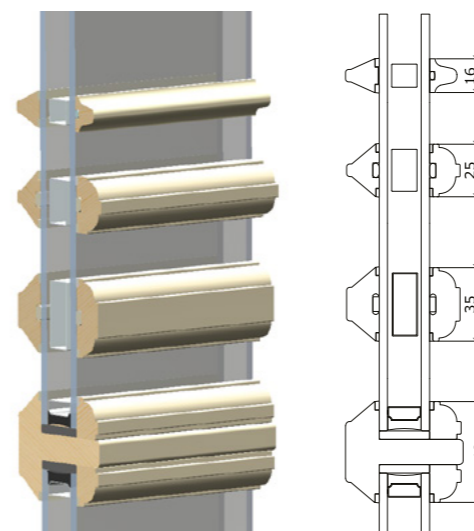

## Heritage

Our Heritage Range incorporates period aesthetics such as internal lambs tongue profile glazing beads and external putty line style to mirror distinctive features of original timber windows.

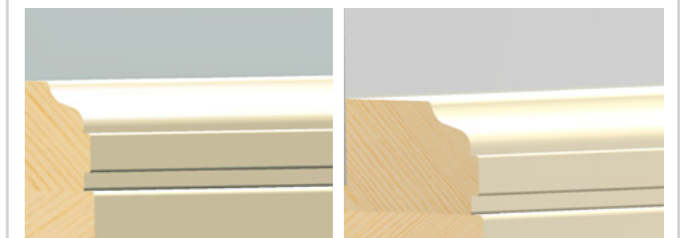

Heritage SlimLine Internal

Heritage Single Internal

## Lambs Tongue Bars

16mm, 25mm, 35mm  
48mm (Solid)

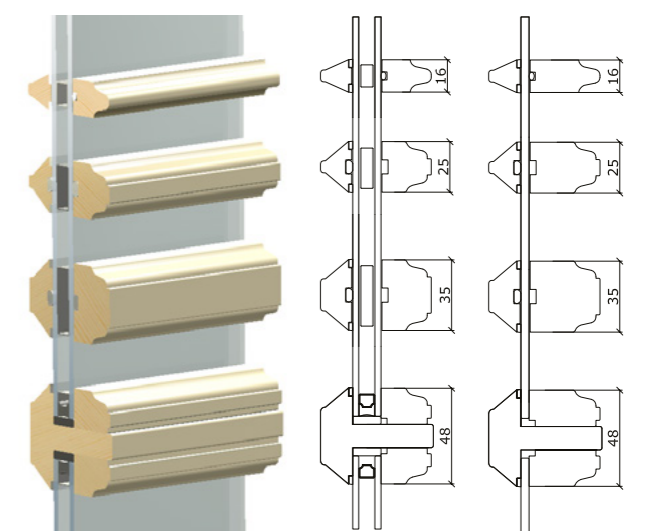



Traditional Flush Casement  
RAL 7030 Stone Grey

## Choose Your Finish

In design it is often the subtle, finer touches that can dramatically transform the appearance of your home. The beauty of wood is that you can be adventurous in your choice of colour and accessorise to your hearts content with traditional and contemporary ironmongery styles.

### Paint & Stain Finishes

Choose from RAL, BS and NCS paint finishes to find the colour that is right for you and your home. If you prefer to allow the natural character, grain and beauty of the timber shine through, choose from our range of 16 translucent stain finishes.

### Dual Finish

Choose a different colour inside and out to match the finish of both the external façade and interior decor of your home.

### Colour Matching

To achieve a timeless finish our colour matching service allows you to choose from the vast range of 132 Farrow & Ball finishes. Also available on dual finish.

### Customised Finish

Our factory painting process allows you to select contrasting finishes to the frame and sash/leaf. Try colour matching your door frame to your window finish or go bold with your door leaf.

Ask our sales team about our exclusive paint and stain booklets containing an impressive range of timber colour swatch samples.



Traditional Flush Entrance Door Curved Head  
Flush Casement | RAL 9010 Pure White



Traditional Flush Entrance Door  
Farrow & Ball No. 25 Downpipe Colour Match

## Be Bold

Be bold with colour to show your personality and create kerb appeal. Opt for a contrasting door leaf and match the door frame to your windows.



## Go Greyscale

Grey is a colour that represents peace and balance. It is calm and safe, practical, simple and reliable. It is the perfect neutral.

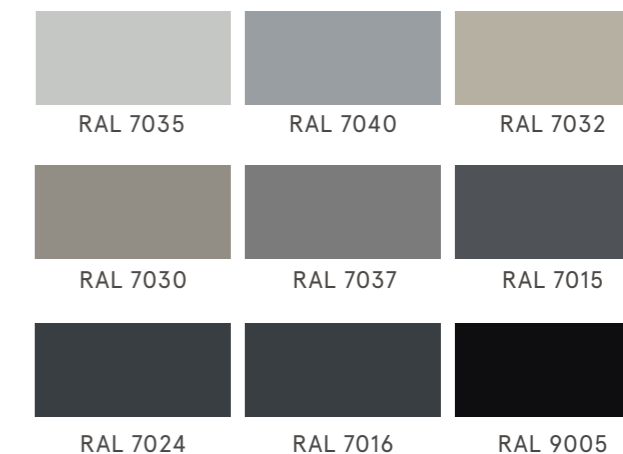

## Popular Pastels

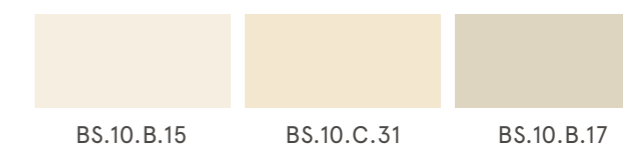

## Heritage Colours



# Customise With Glazing & Bars

## Bespoke Designs

Your dedicated technical project manager will provide design advice and specialist CAD drawings at order stage.



Heritage Angled Feature Frame | RAL 9016 Traffic White | 25mm Bar



Curved Head Sliding Sash Lookalike | Contemporary Profile  
RAL 9016 Traffic White | 60mm Solid Bar & 16mm Bespoke Curved Bar

## Coloured & Bevelled

Matching existing styles is made possible with a range of coloured and bevelled glass options.



Blue Coloured Glass



Traditional Flush French Doors | Blue Coloured Glass

## Leaded Designs

We can offer completely bespoke lead patterns in 6mm & 9mm Antique Black, Silver & Gold.



Traditional Flush Casement | Bespoke Lead Design



Traditional Flush Casement | RAL 9016 Traffic White | 6mm Lead Antique Black



Contemporary Range Sliding Sash Spiral Balance | RAL 9001 | 16mm Bar

## Privacy

The ideal way to increase privacy in the home, our obscure glazing patterns are available in a range of designs offering varying privacy levels (rated 1-5 with 5 being the highest obscurity level).

S = 4mm Standard Float Glass T = 4mm Toughened Glass L = 6.4mm Laminated Glass



Frosted - 5 S,T,L

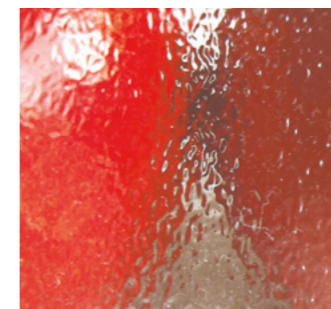

Stippolyte - 4 S,T



Kocie - 4 S,T

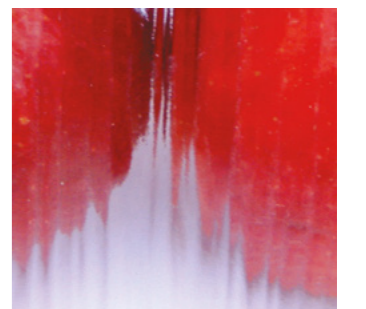

Cotswold - 5 S,T



Chinchilla - 3 S,T

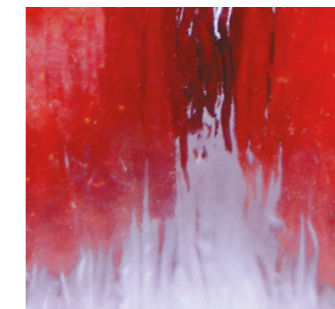

Kora - 4 S,T

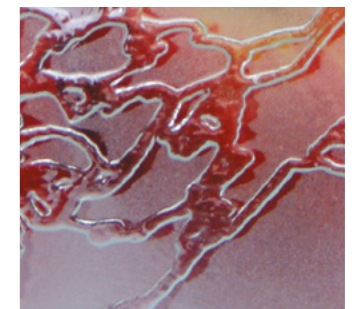

Delta - 5 S,T

# Finishing Touches





# Our Showroom



Traditional Flush Casement | Antique Black Monkey Tail Handle & Stay | 175mm Window Board

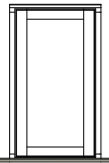
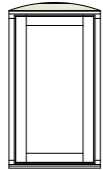
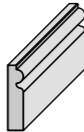
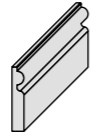
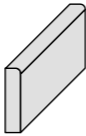
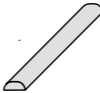
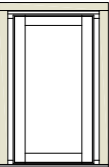
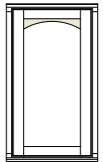
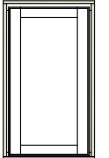

Colour match your internal finishes with our range of factory finished redwood or hardwood trims.

					
<b>Cill Horns</b>	<b>Arched Head Packer</b>	<b>Torus Architrave</b>	<b>Torus Trim</b>	<b>Pencil Round</b>	<b>D Mould</b>
		18 x 50 18 x 75 18 x 100	12 x 60 12 x 100 12 x 150 12 x 200 12 x 250	18 x 50 18 x 75 18 x 100	10 x 25
					
<b>Packer</b>	<b>Curved Plate</b>				
					
<b>Cheeks</b>	<b>Quadrant</b>	<b>Fillet Bead</b>	<b>Window Board</b>		
	20 x 20	18 x 30 18 x 75 18 x 100	25 x 175 25 x 225 25 x 300		

## Get in touch

Come and visit our showroom where our highly experienced staff will be happy to guide you through choosing your new bespoke timber windows and doors.

01709 838188  
info@bereco.co.uk

**Bereco Group**  
Unit 4-5 Aspen Court  
Centurion Business Park  
Bessemer Way  
Rotherham  
S60 1FB

Find Bereco on social media



@berecowindows



 **Bereco**  
01709 838188  
[www.bereco.co.uk](http://www.bereco.co.uk)

