

**Heritage Slim-Line Open In Flush French Door  
Cill Extension Options**

DIMENSIONS	PLOT SIZE	SCALE	DATE	REV	DWG NO.
MM	A4	1:1	25.09.2019	B	<b>4601</b>

Please consider the environment before printing

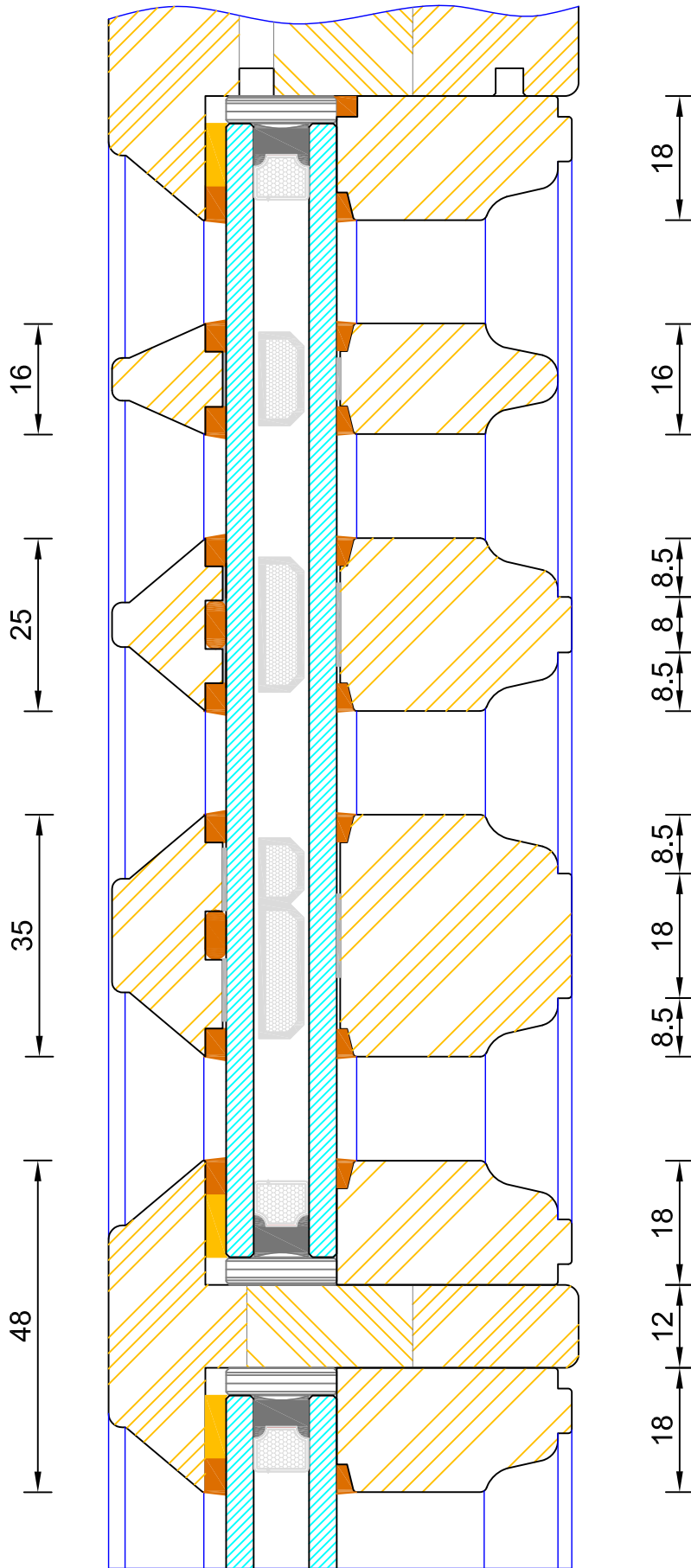

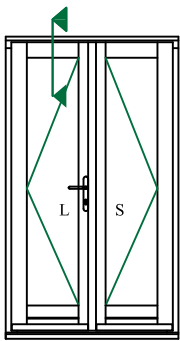
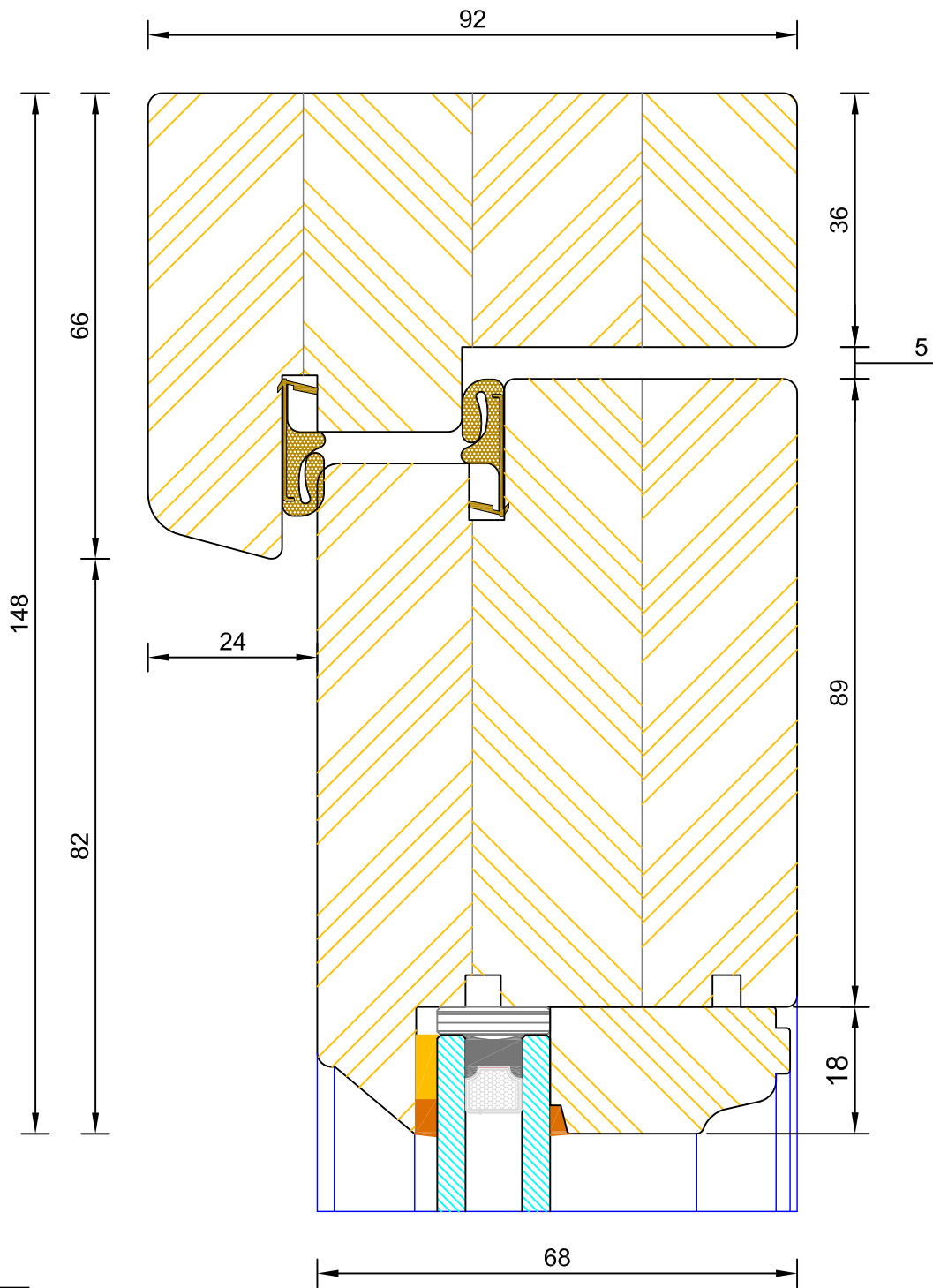

### Heritage Slim-Line Open In Flush French Door Frame & Leaf Head

DIMENSIONS	PLOT SIZE	SCALE	DATE	REV	DWG NO.
MM	A4	1:1	01.01.2019	B	<b>4603</b>
Please consider the environment before printing					

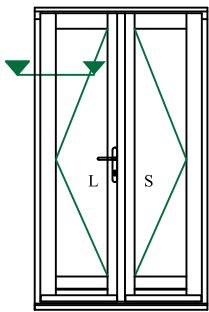
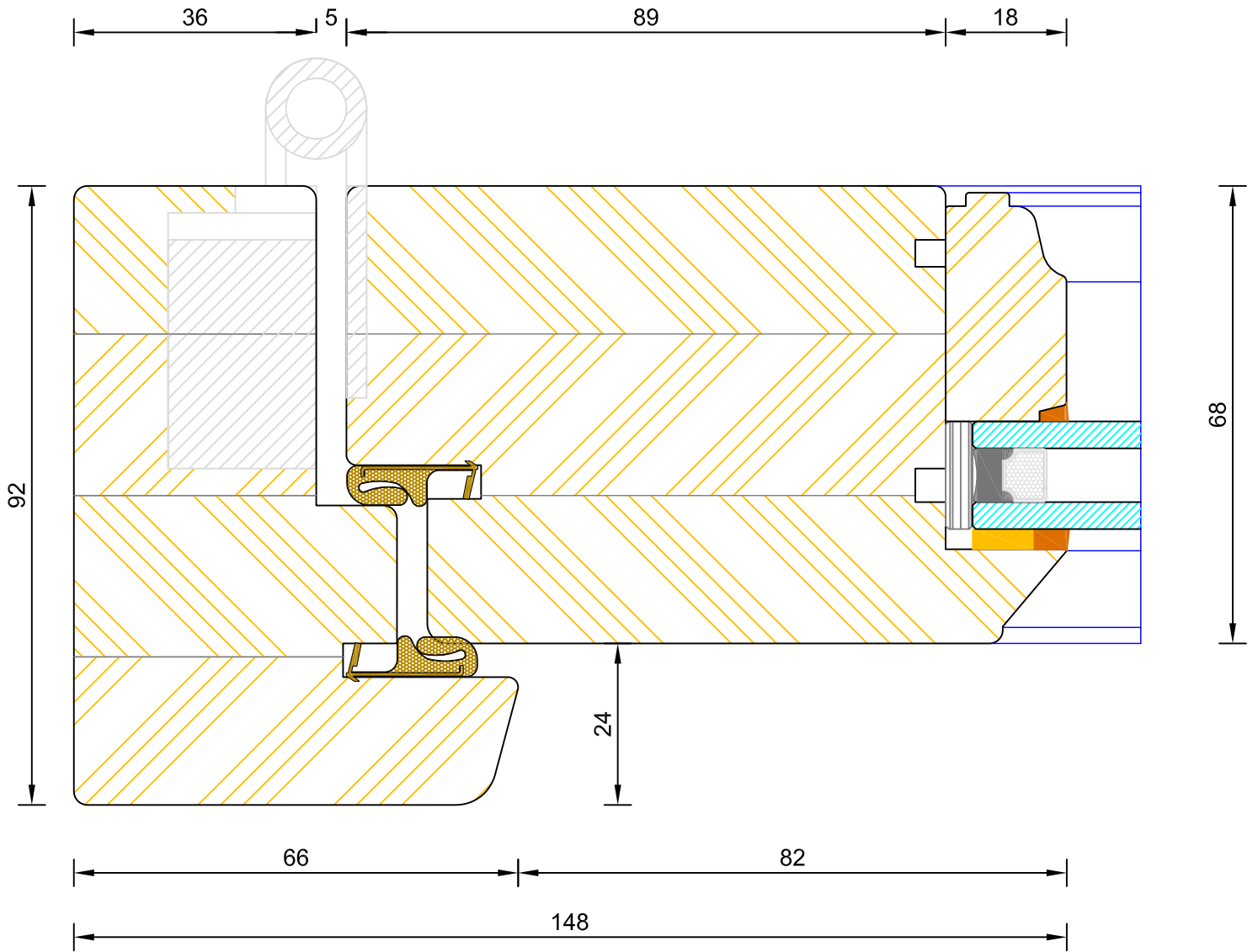



# Bereco

## Heritage Slim-Line Open In Flush French Door Flying Mullion (Double Handle)

Please consider the environment before printing

DIMENSIONS	PLOT SIZE	SCALE	DATE	REV	DWG. NO.
MM	A4	1:1	01.01.2019	B	<b>4605</b>

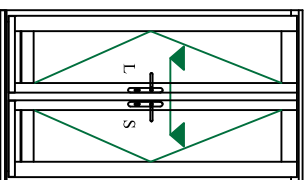
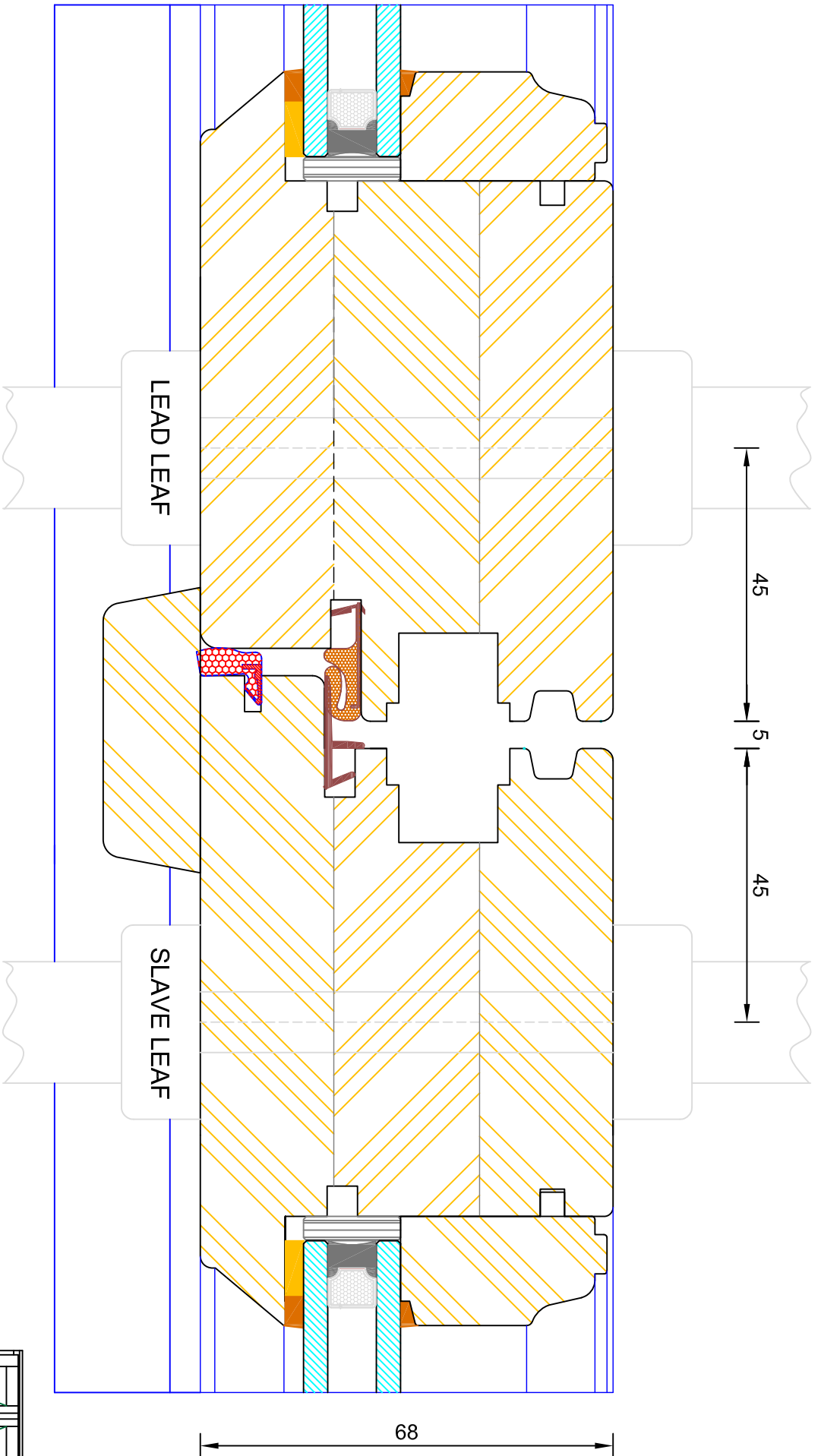

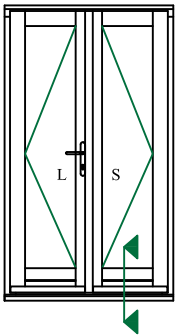
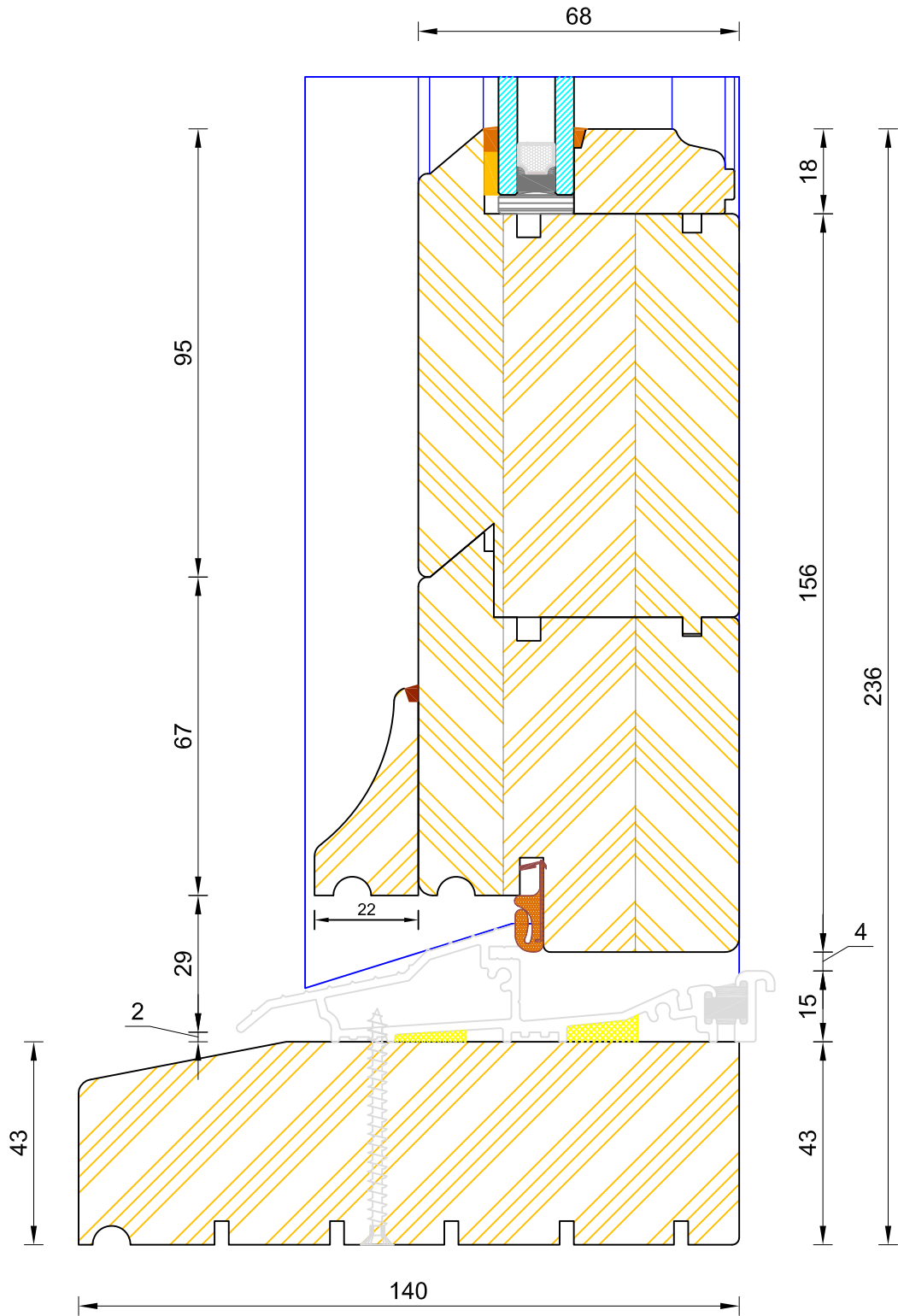

If not otherwise stated, Hardwood Threshold will be stained 5064 Walnut.



### Heritage Slim-Line Open In Flush French Door Standard Thresh (140x43mm)

DIMENSIONS	PLOT SIZE	SCALE	DATE	REV	DWG NO.
MM	A3	1:1	01.01.2019	B	<b>4606</b>
Please consider the environment before printing					

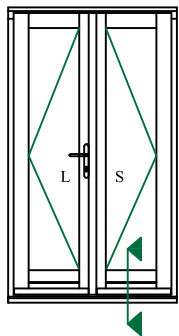
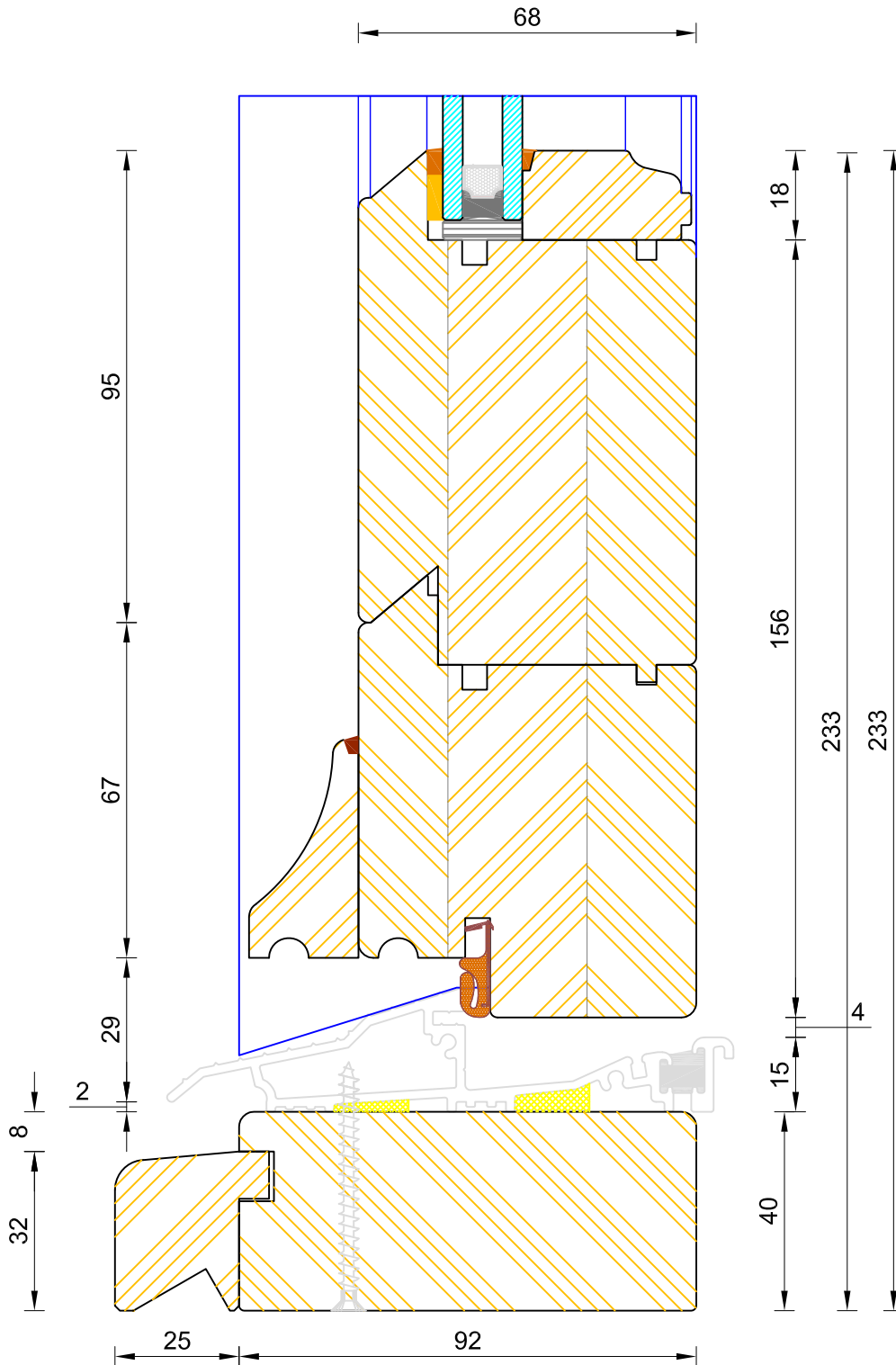

CILL EXTENSION - available options: 25mm (237mm o/a) / 47mm (139mm o/a) / 62mm (154mm o/a) / 87mm (179mm o/a) / 100mm (192mm o/a) / 125mm (217mm o/a) / 140mm (232mm o/a)

NOTE: Cill Extensions should be supported from underneath; the maximum overhang over Brick / Blockwork for cill extension should not exceed 25mm in order to avoid damage when stepped on. Warranties are invalidated when fitted with overhang in excess to that.

If not otherwise stated, Hardwood Threshold will be stained 5064 Walnut.



### Heritage Slim-Line Open In Flush French Door Coupling Thresh

DIMENSIONS	PLOT SIZE	SCALE	DATE	REV	DWG NO.
MM	A3	1:1	01.01.2019	B	<b>4607</b>
Please consider the environment before printing					

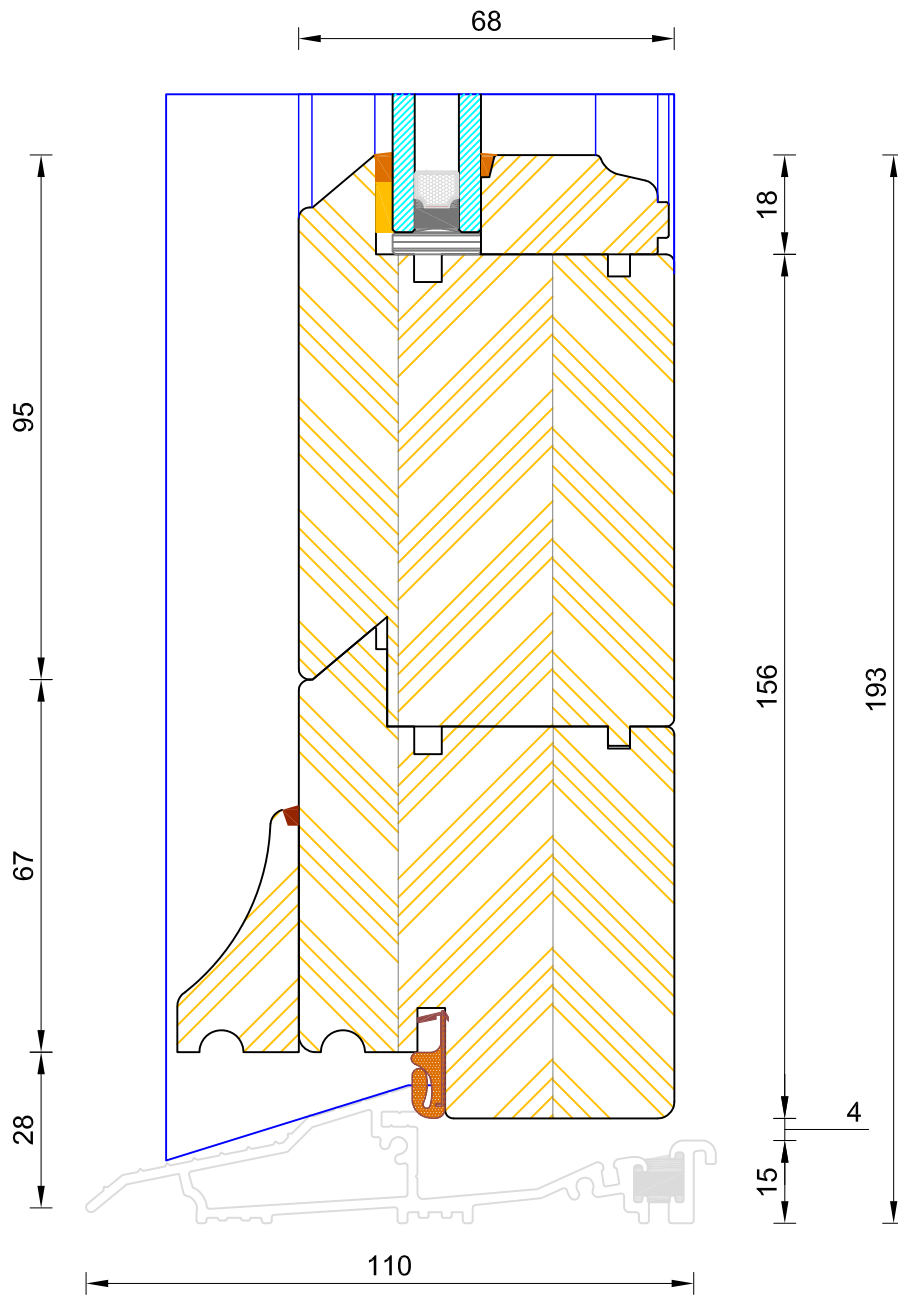
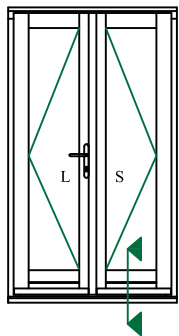

**Heritage Slim-Line Open In Flush French Door  
Mobility Threshold**

DIMENSIONS	PLOT SIZE	SCALE	DATE	REV	DWG NO.
MM	A3	1:1	01.01.2019	B	<b>4608</b>
Please consider the environment before printing					



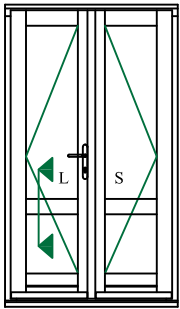
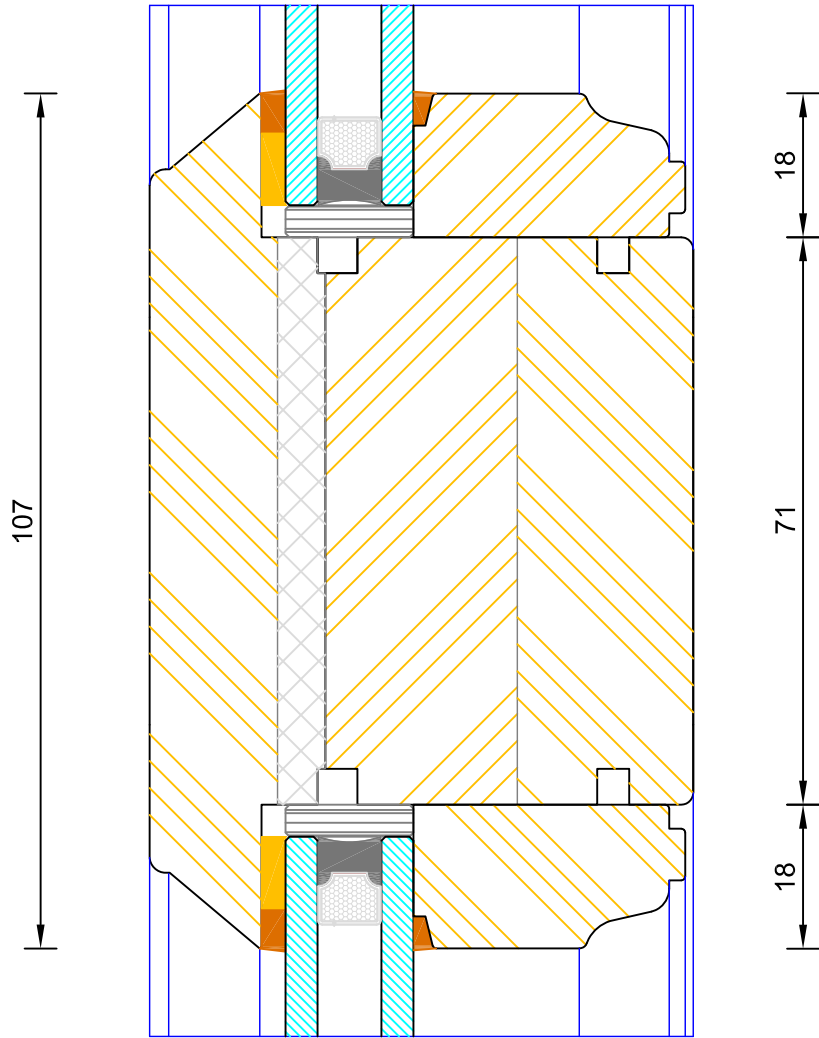

**Heritage Slim-Line Open In Flush French Door  
Mid Rail**

DIMENSIONS	PLOT SIZE	SCALE	DATE	REV	DWG NO.
MM	A4	1:1	01.01.2019	B	<b>4609</b>
Please consider the environment before printing					