

**Heritage Single Glazed Open Out Flush French Door  
Cill Extension Options**

DIMENSIONS	PLOT SIZE	SCALE	DATE	REV	DWG NO.
MM	A4	1:1	25.09.2019	B	<b>4501</b>

Please consider the environment before printing

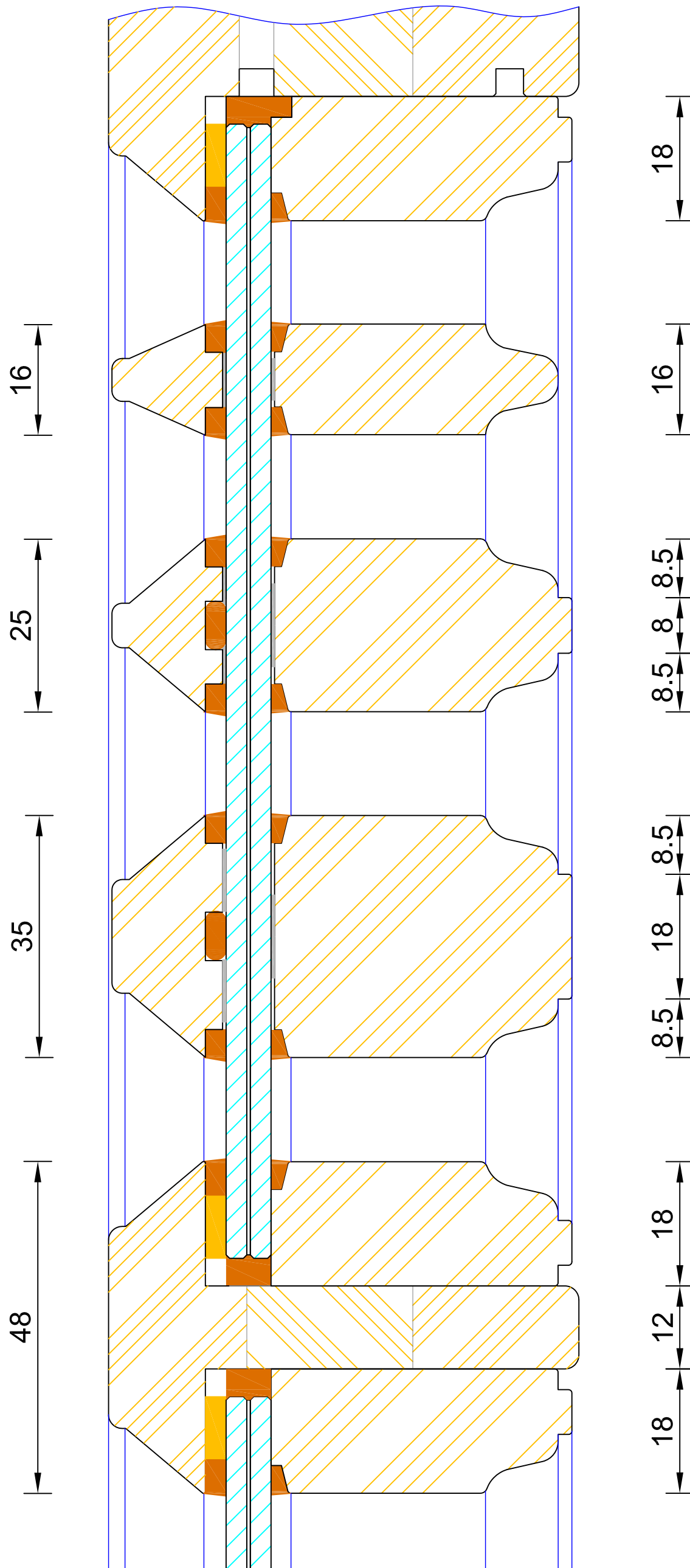

**Bereco**

**Heritage Single Glazed Open Out Flush French Door Bar Options**

DIMENSIONS	PLOT SIZE	SCALE	DATE	REV	DWG NO.
MM	A4	1:1			<b>4502</b>

 Please consider the environment before printing

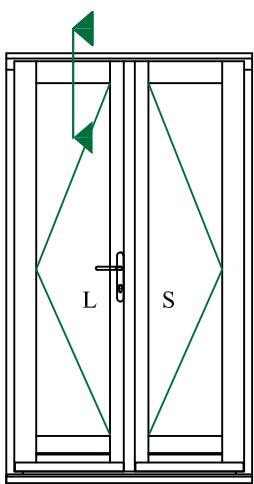
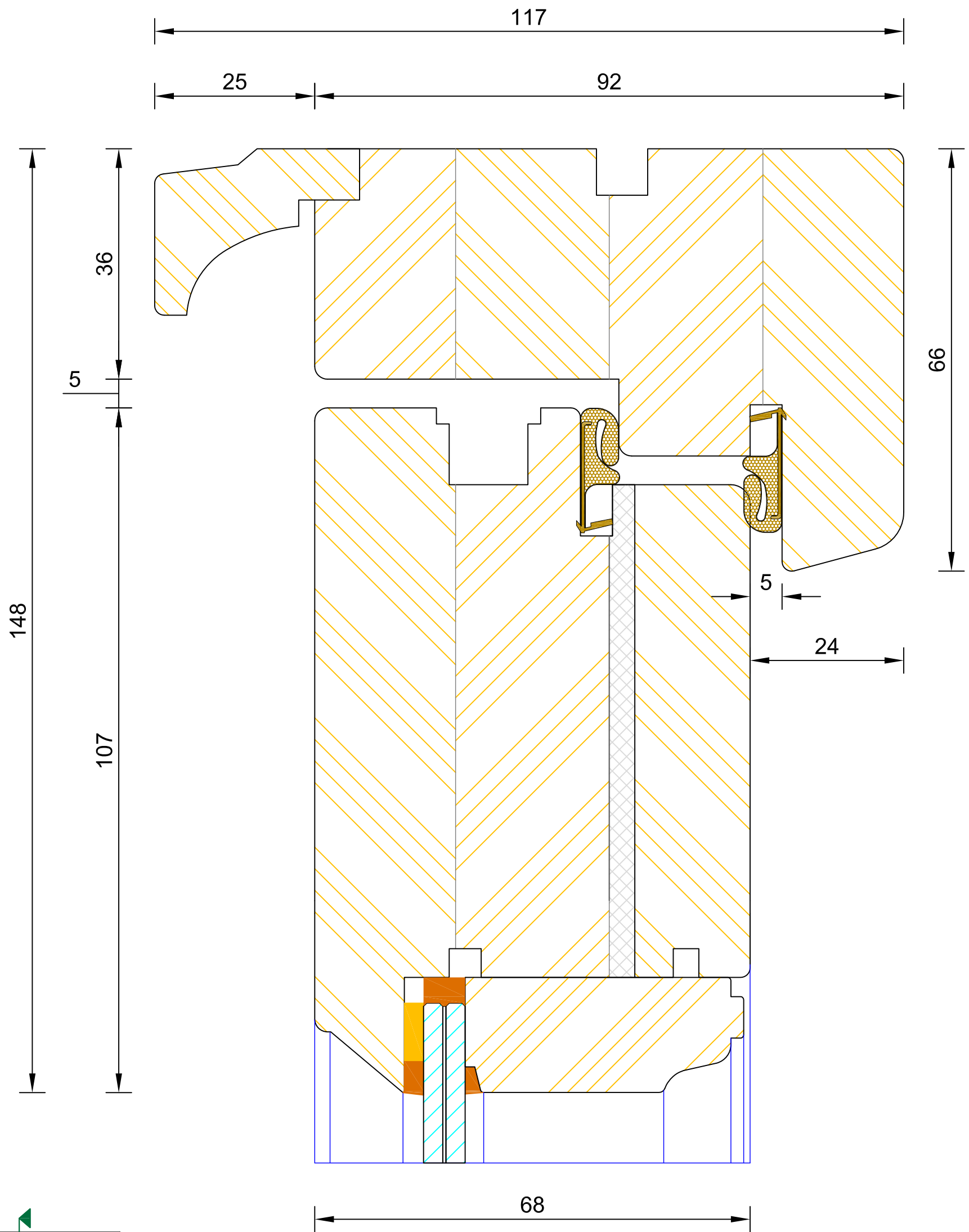

**Heritage Single Glazed Open Out Flush French Door  
Frame & Leaf Head**

DIMENSIONS	PLOT SIZE	SCALE	DATE	REV	DWG NO.
MM	A4	1:1	01.01.2019	B	<b>4503</b>

Please consider the environment before printing

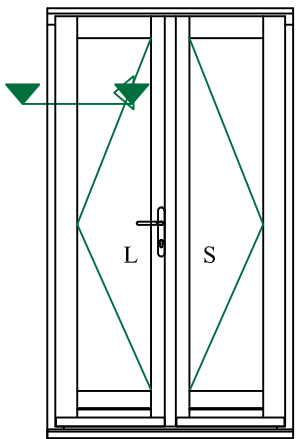
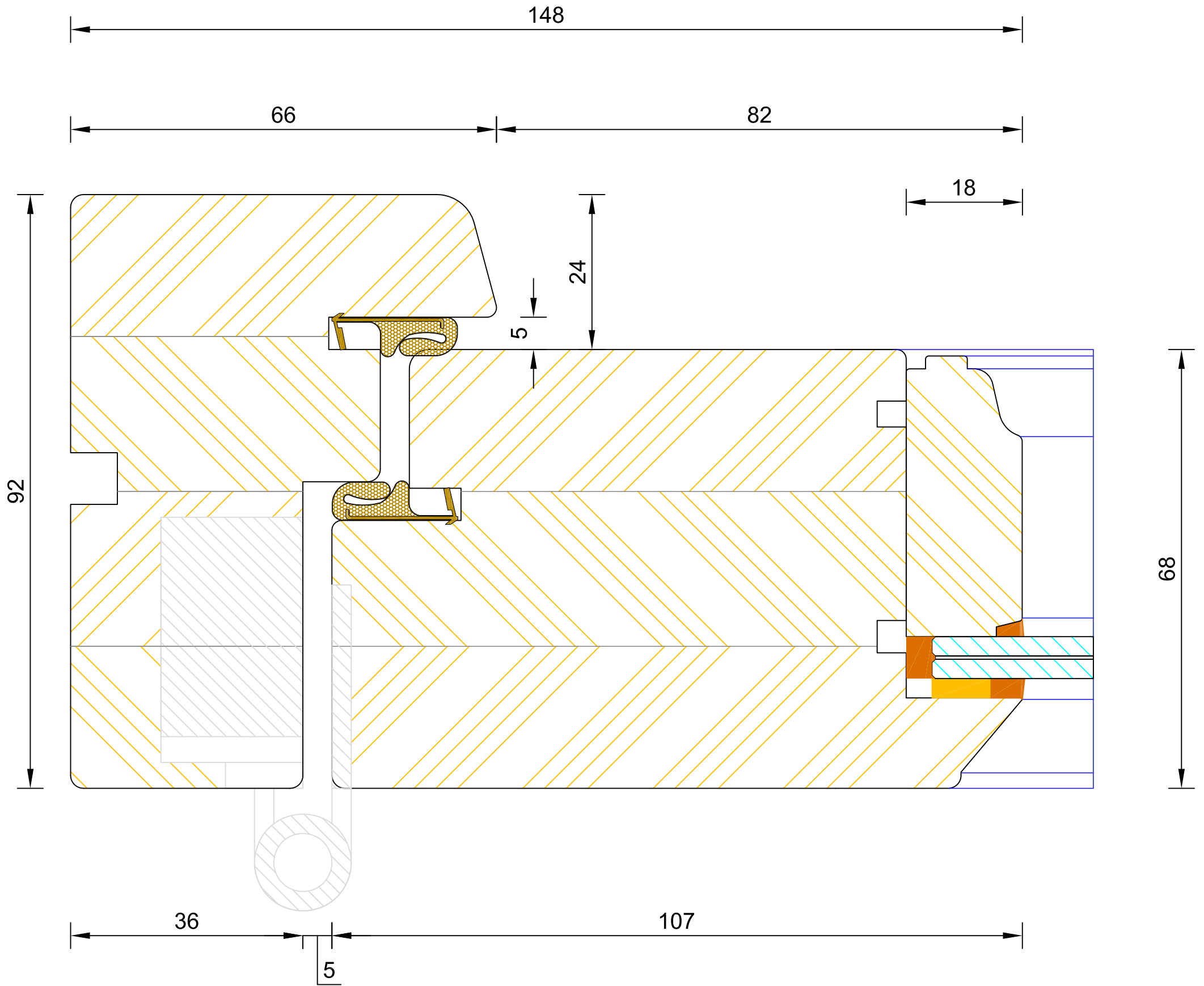

**Heritage Single Glazed Open Out Flush French Door  
Frame & Leaf Jamb**

DIMENSIONS	PLOT SIZE	SCALE	DATE	REV	DWG NO.
MM	A4	1:1	01.01.2019	B	<b>4504</b>

 Please consider the environment before printing

207

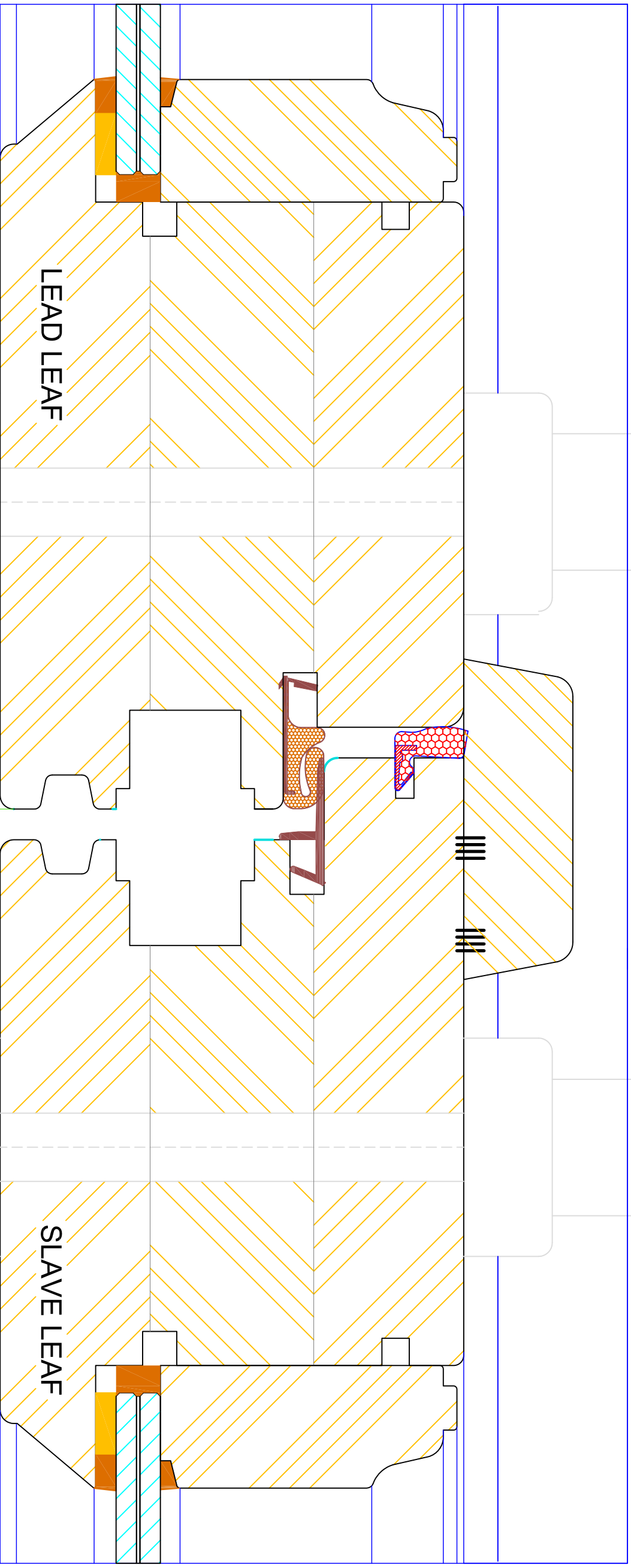

68

D=45

5

D=45

### Heritage Single Glazed Open Out Flush French Door Flying Mullion (Double Handle)

DIMENSIONS	PLOT SIZE	SCALE	DATE	REV	DWG NO.
MM	A4	1:1	01.01.2019	B	4505

Please consider the environment before printing

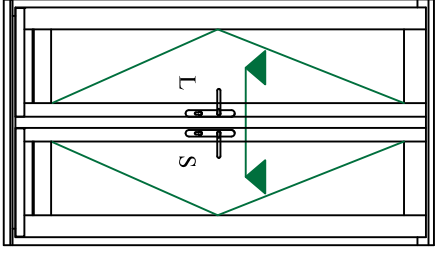

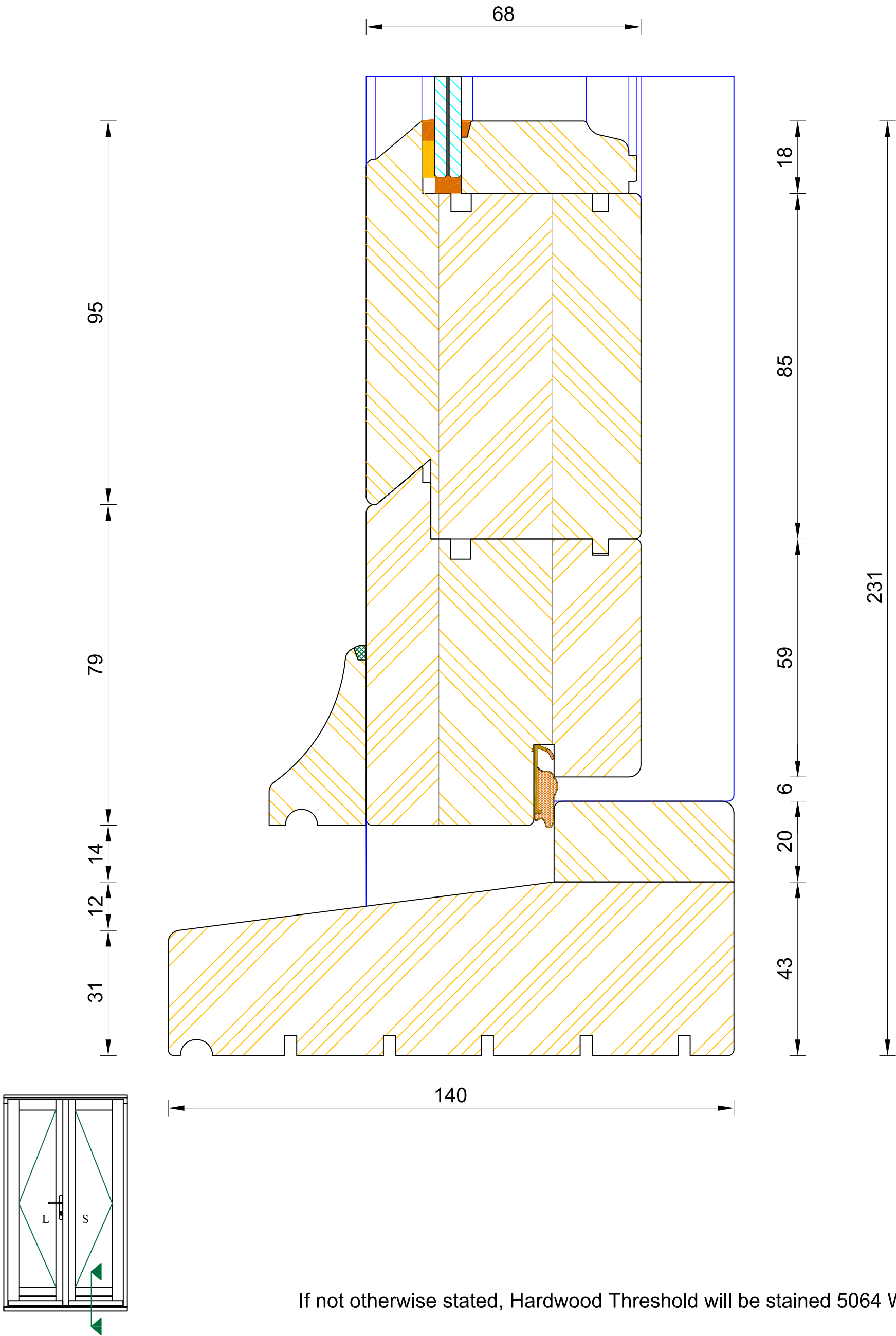

If not otherwise stated, Hardwood Threshold will be stained 5064 Walnut.



**Heritage Single Glazed Open Out Flush French Door  
Standard Thresh (140x43mm)**

DIMENSIONS	PLOT SIZE	SCALE	DATE	REV	DWG NO.
MM	A3	1:1	01.01.2019	B	<b>4506</b>

Please consider the environment before printing

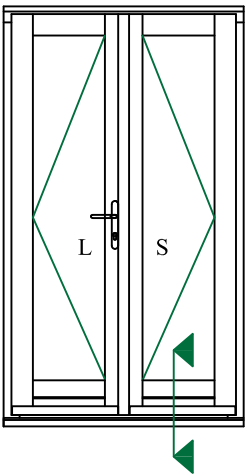
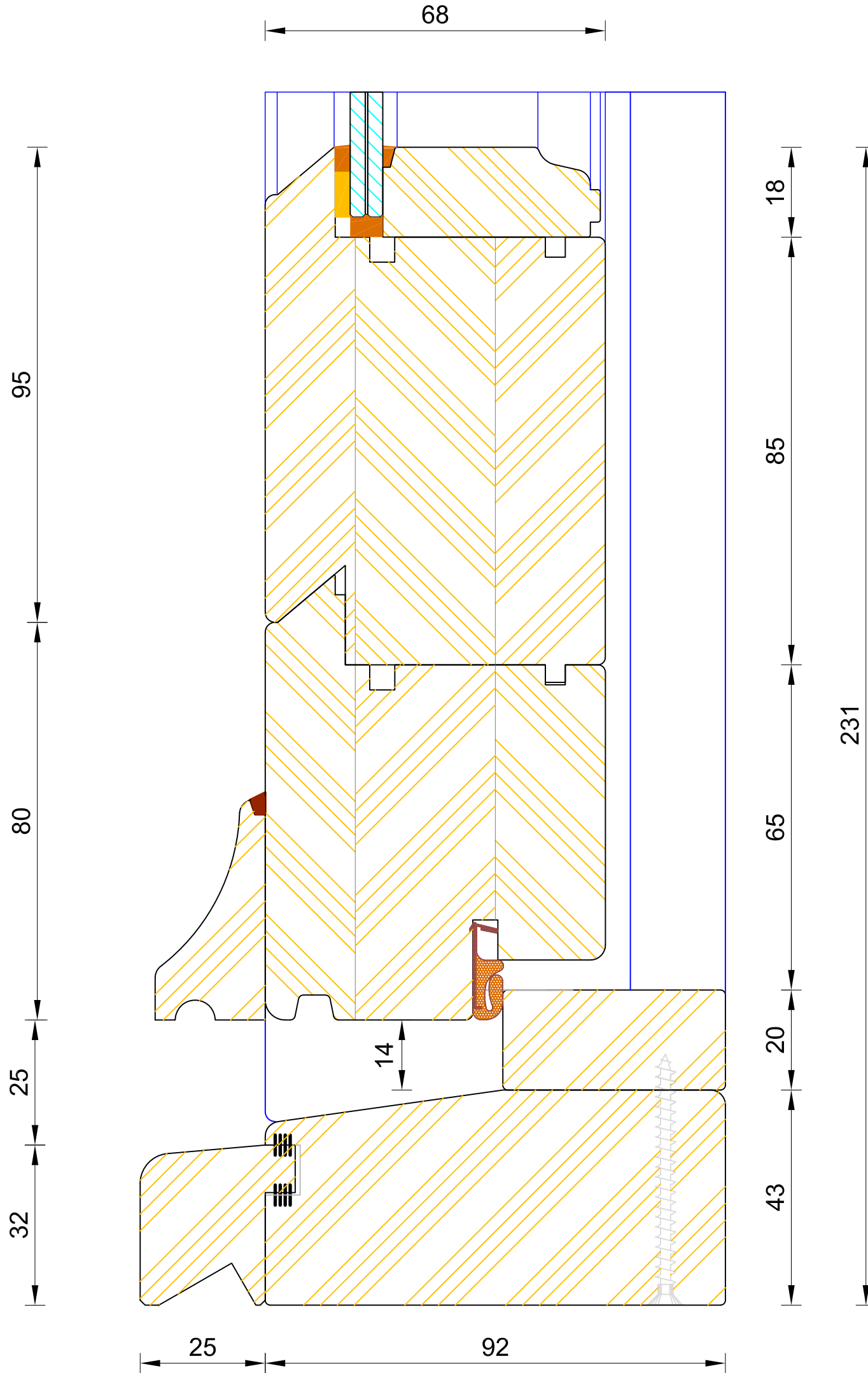

CILL EXTENSION - available options: 25mm (237mm o/a) / 47mm (139mm o/a) / 62mm (154mm o/a) / 87mm (179mm o/a) / 100mm (192mm o/a) / 125mm (217mm o/a) / 140mm (232mm o/a)

NOTE: Cill Extensions should be supported from underneath; the maximum overhang over Brick / Blockwork for cill extension should not exceed 25mm in order to avoid damage when stepped on. Warranties are invalidated when fitted with overhang in excess to that.

If not otherwise stated, Hardwood Threshold will be stained 5064 Walnut.



### Heritage Single Glazed Open Out Flush French Door Coupling Thresh

DIMENSIONS	PLOT SIZE	SCALE	DATE	REV	DWG NO.
MM	A3	1:1	01.01.2019	B	<b>4507</b>

Please consider the environment before printing

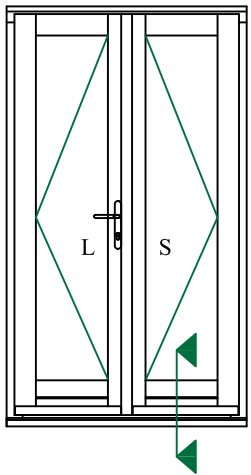
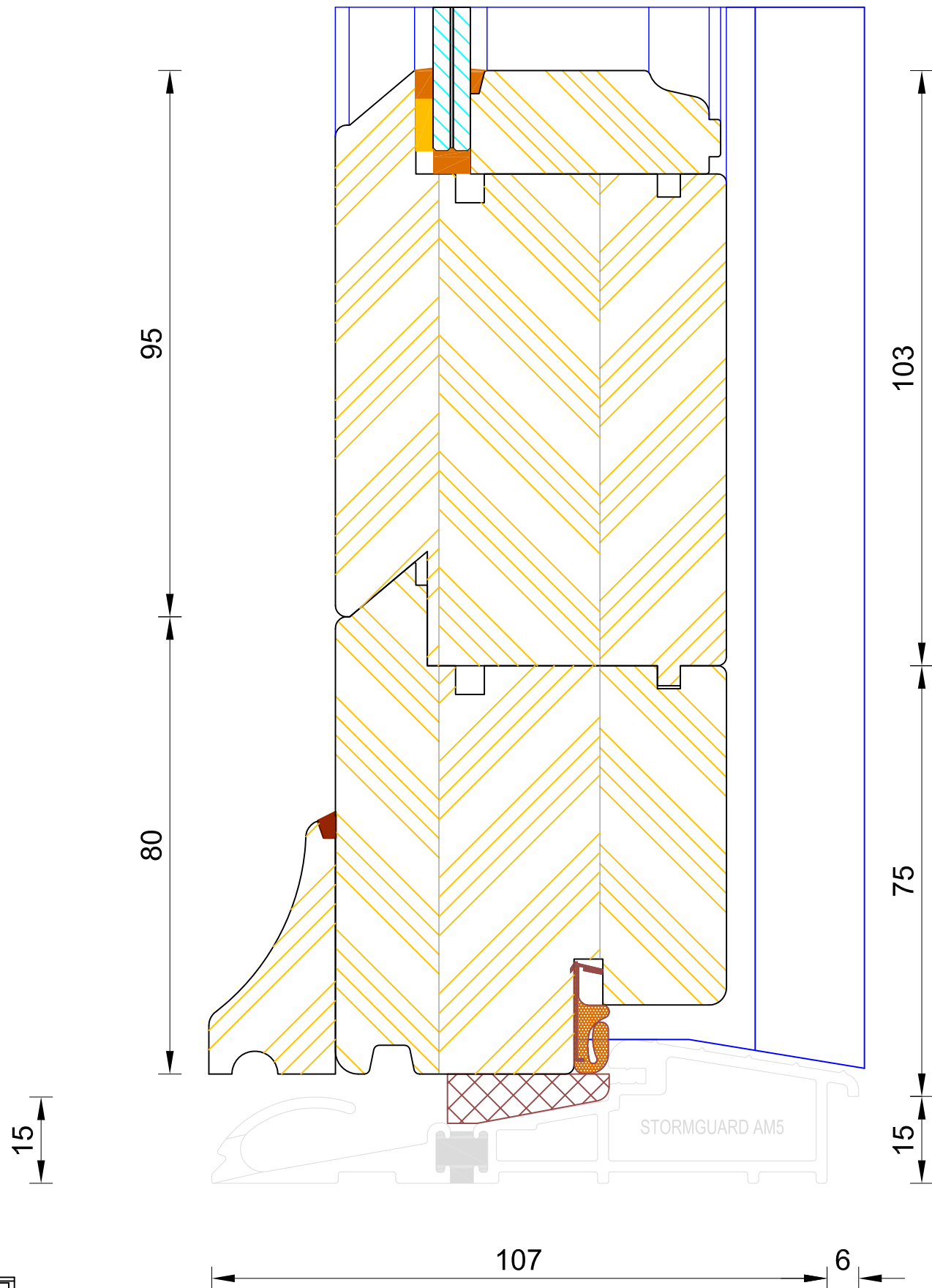

**Heritage Single Glazed Open Out Flush French Door  
Mobility Threshold**

DIMENSIONS	PLOT SIZE	SCALE	DATE	REV	DWG NO.
MM	A3	1:1	01.01.2019	B	<b>4508</b>

Please consider the environment before printing



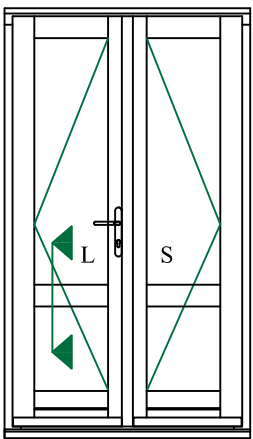
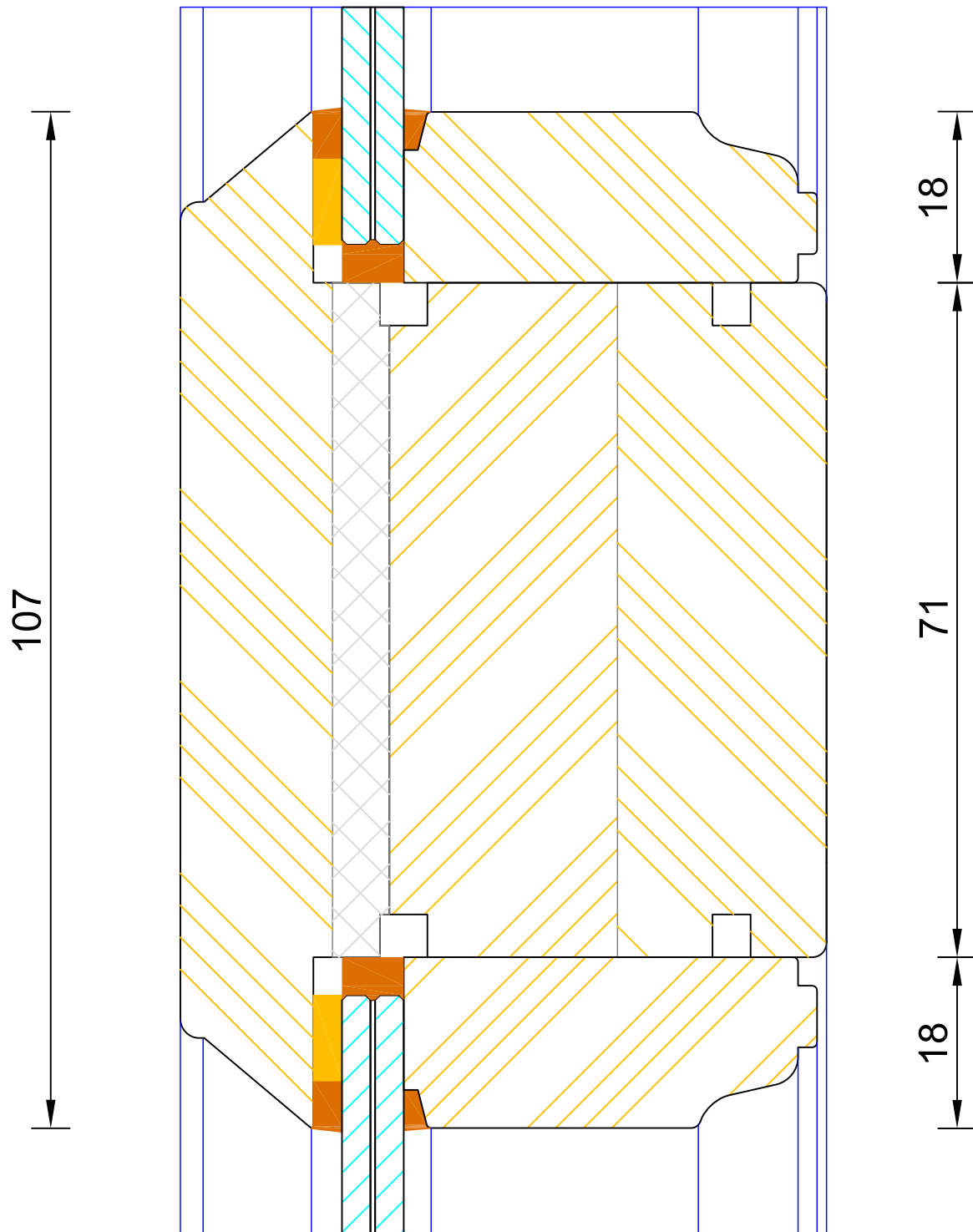

DIMENSIONS	PLOT SIZE	SCALE	DATE	REV	DWG NO.
MM	A4	1:1	01.01.2019	B	<b>4509</b>